

**PURCHASE COLLEGE ADVANCEMENT CORPORATION (PCAC)
REQUEST FOR PROPOSALS (RFP) SU-070213-2**

RFP Number
SU-070213-2

Dated
October 8, 2013

Description
Operations Management for a
Senior Learning Community
at Purchase College, State University of New York

Contract Term
Ten years, beginning on or about March 1, 2014

Calendar of Events - Procurement Timetable
Release of RFP..... October 8, 2013
Pre-Bid Meeting..... November 4, 2013
Question Period.....November 5, 2013 – November 15, 2013
Answers to Questions November 25, 2013
Proposal Due Date/Time:.....December 17, 2013/2:00 pm
InterviewsJanuary 6, 2014 – January 24, 2014
Anticipated Awardee NotificationFebruary 7, 2014
Vendor De-Briefingupon request after notice of award

Location of Service
Purchase College
State University of New York
735 Anderson Hill Road
Purchase, New York 10577

Designated Contacts
For New York State/SUNY administrative policy/procedure:
Nikolaus D. Lentner
Director of Purchasing & Accounts Payable
telephone 914-251-6070
fax 914-251-6075
email L@purchase.edu

<u>Package Contains</u>	<u>Page</u>
Part I: General Information	1-9
Part II: Detailed Specifications.....	10-27
Standard Contract Clauses.....	Exhibit A
Affirmative Action Clauses.....	Exhibit A-1
Submission Form – Bid Proposer Info	Attachment 1
Enabling Legislation.....	Attachment 2
Vicinity Map.....	Attachment 3
Aerial and Topographic Maps	Attachment 4
Utility Report.....	Attachment 5
Preliminary Geotechnical Report.....	Attachment 6
Concept Plans.....	Attachment 7

For technical information & clarification of detailed specifications:
Wayne M. Rush, P.E.
Project Manager
telephone 914-251-6138
fax 914-251-6041
email wayne.rush@purchase.edu

PART I: GENERAL STANDARD INFORMATION AND INSTRUCTIONS

- A. Request for Proposal (RFP)
Purchase College Advancement Corporation (PCAC) is dedicated to environmentally sustainable practices. In an effort to conserve resources and reduce waste, the RFP will only be available electronically in PDF format at the following website: <http://www.purchase.edu/purchasemeansbusiness> (and click Current Procurement Opportunities).
- B. Proposal Submission
When submitting a Proposal, you must:
1. Prepare a clearly readable document. Attach all required information.
 2. Indicate any deviations from the specifications and if necessary attach separate documents and/or explanation.
 3. **Sign the Proposal.** By signing you indicate full knowledge and acceptance of this Request for Proposal (RFP) including Exhibits A and A-1. The Proposal must be completed in the name of the proposer, corporate or otherwise, and must be fully and properly executed by an authorized person.
 4. **Submit eight (8) complete bound proposals, one of which must have original signatures.** Proposals should be sealed and submitted as specified in Part II. Proposals are to be addressed to:
Nikolaus D. Lentner, Director
Purchasing & Accounts Payable Office
State University of New York
Purchase College
735 Anderson Hill Road
Purchase, NY 10577-1402

5. Proposals must be received in the Purchasing & Accounts Payable Office by the due date and time. Offerers mailing their Proposals must allow sufficient time to ensure receipt of their Proposals by the time specified. Offerers are cautioned that, although using a trackable mailing/courier/messenger service, Proposals must be received in the Purchasing & Accounts Payable Office by the due date and time. While Proposals may be signed for by Purchase College Mail Operations personnel prior to the due date and time, this does not guarantee that the Purchasing & Accounts Payable Office will receive the Proposal by the Proposal due time. No Proposal will be considered that is not physically received in the Purchasing & Accounts Payable Office by the Proposal due date and time. Electronically transmitted Proposals will **NOT** be accepted.

C. Pre-Bid Proposal Meeting

There will be a non-mandatory Pre-Bid Proposal vendor meeting on the date and time indicated on page 1 in the Calendar of Events - Procurement Timetable in the Student Services Building, Conference Room 0129 (the "Red Room") at Purchase College, State University of New York, 735 Anderson Hill Road, Purchase, New York 10577.

For directions to Purchase College, see <http://www.purchase.edu/AboutPurchase/VisitorsGuide/Directions/>

For a campus map, see <http://www.purchase.edu/sharedmedia/admissions/campus%20map.pdf>

D. Open Question Period

The PCAC will allow for a question/answer period as indicated in the Calendar of Events– Procurement Timetable on page 1. All questions must be submitted in writing, citing the particular RFP page, section and paragraph numbers where applicable. All questions must be EMAILED to arrive no later than the Close of Business on the date indicated, and should be directed to email address wayne.rush@purchase.edu. Questions received after the closing date for inquiries will not be answered. Only written answers are official. All questions and answers will be issued as addenda to this RFP, and will be posted to <http://www.purchase.edu/purchasemeansbusiness> by the date indicated on page 1.

E. Vendor De-Briefing Meeting

Upon notification of the selection and award of a contract, unsuccessful vendors are entitled to, and shall receive, upon request, a debriefing of the results of their response to this Request for Proposals. Request for debriefing by an unsuccessful bidder should be made within thirty (30) days after the award of the contract.

F. Contract Award Protest Procedure

Upon notification of the selection and award of the contract, the bidder or offeror whose bid or proposal was not selected as the successful bid or proposal is entitled to submit a Bid Protest in accordance with SUNY's Contracts Award Procedure (Document # 7561). The SUNY's Protest Procedure is available at http://www.suny.edu/sunypp/documents.cfm?doc_id=699. Please note that the Protest Officer is Nikolaus D. Lentner; contact information is located on page 1 of this RFP.

G. Standard Contract Clauses

Any contract resulting from this RFP shall include Exhibit A (Standard Contract Clauses, State University of New York) and Exhibit A-1 (Affirmative Action Clauses, State University of New York), the provisions of which shall take precedence over any provision in the RFP. These clauses relate to, among other things, assignment of the contract, availability of funds, non-discrimination, affirmative action, non-collusion, worker's compensation.

H. Affirmative Action Policy

New York State Executive Order No. 6, regarding equal employment opportunities states:

It is the policy of the State of New York that equal opportunity be assured in the State's personnel system and affirmative action provided in its administration in accordance with the requirement of the State's Human Rights Law and the mandate of Title VII of the Federal Civil Rights Act, as amended. Accordingly, it is the responsibility of the State's Department of Civil Service to enforce the State's policy of ensuring full and equal opportunity for minorities, women, disabled persons and Vietnam era veteran's at all occupational levels of state government.

In keeping with this policy, PCAC mandates compliance internally and for all organizations with which it conducts business. The determination of contract award will include a review of evidence supplied by each Offerer regarding compliance with the State's Affirmative Action policy. Accordingly, an Offerer's Proposal must include its organization's affirmative action policy, and agree that all presentations and materials will be free from racial, religious, or sexual bias.

I. Minority and Women-owned Business Enterprises

It is the policy of the State University of New York to take affirmative action to ensure that minority and women-owned business enterprises are given the opportunity to demonstrate their ability to provide goods and services at competitive prices.

GOALS FOR MINORITY AND WOMEN-OWNED BUSINESS ENTERPRISES PARTICIPATION: For all State Contracts in excess of \$25,000.00 whereby each SUNY campus is committed to expend or does expend funds in return for labor, services including but not limited to legal, financial and other professional services, supplies, equipment, materials or a combination of the

foregoing or all State Contracts in excess of \$100,000.00 whereby Purchase College is committed to expend or does expend funds for the acquisition, construction, demolition, replacement, major repair or renovation of real property and improvements thereon, Contractor shall exert good faith efforts to achieve a participation goal of **fourteen percent (14%)** for certified Minority-Owned Business Enterprises and **twelve percent (12%)** for certified Women-Owned Business Enterprises.

J. Gramm-Leach-Bliley Act

In performing this contract contractor will receive, maintain process or otherwise will have access to confidential information on students and/or customers of Purchase College. Pursuant to the Gramm-Leach-Bliley Act (P.L. 106-102) and the Federal Trade Commission's Safeguards Rule (16 CFR Part 314.2), you must implement and maintain a written Information Security Program in order to protect such customer information. Customer information is defined in relevant part under the Safeguards Rule as "any record containing nonpublic personal information as defined in 16 CFR §313(n)" (the FTC's Privacy Rule) "about a customer of a financial institution, whether in paper, electronic or other form" (16 CFR §314.2). Examples of nonpublic personal customer information include, but are not limited to, name, address, phone number, social security number, bank and credit card account numbers and student identification numbers.

The safeguards that contractor implements under the Program must comply with the elements set forth in 16 CFR §314.4 and must achieve the objectives enunciated in 16 CFR §314.3, namely to: 1) insure the security and confidentiality of student and/or campus customer records and information; 2) protect against any anticipated threats or hazards to the security or integrity of such records; and 3) protect against unauthorized access to or use of such records or information which could result in substantial harm or inconvenience to any student and/or campus customer.

K. Proposal Confidentiality

All Proposals submitted for Purchase College Advancement Corporation consideration will be held in confidence. However, the resulting contract is subject to the New York State Freedom of Information Law (FOIL). Therefore, if an Offerer believes that any information in its Proposal constitutes a trade secret or should otherwise be treated as confidential and wishes such information not to be disclosed if requested, pursuant to FOIL, (Article 6 of the Public Officers' Law), the Offerer shall submit with its Proposal a separate letter addressed to: Nikolaus D. Lentner, *Records Access Officer, Purchase College, State University of New York, 735 Anderson Hill Road, Purchase, NY 10577-1402*, specifically identifying the page number(s), line(s) or other appropriate designation(s) containing such information, explaining in detail why such information is a trade secret and formally requesting that such information be kept confidential. Failure by an Offerer to submit such a letter with its Proposal identifying trade secrets will constitute a waiver by the Offerer of any rights it may have under Section 89(5) of the Public Officers' Law relating to protection of trade secrets. The proprietary nature of the information designated confidential by the Offerer may be subject to disclosure if ordered by a court of competent jurisdiction. A request that an entire Proposal be kept confidential is not advisable since a Proposal cannot reasonably consist of all data subject to FOIL proprietary status.

L. Sustainable Procurement

It is expected that Contractor will support the purchase of products that will minimize any negative environmental impacts of the contract. In order to facilitate a healthy market in sustainable products, all parties involved in the procurement and utilization of materials must engage in both waste recycling and the initial purchase of products containing recycled content. It is in the interest of public health, safety and welfare and the conservation of energy and natural resources to use and promote environmentally responsible products, including packaging and transportation products and methods.

The successful vendor shall comply, when applicable, with the policy of the State of New York and the State University of New York that all purchases shall incorporate sustainable procurement policies and practices.

In accordance with the provisions of Section 165(3) of the State Finance Law:

The State University of New York is required to purchase recycled products, if available, made with recycled content in accordance with rules and regulations established by the State Department of Environmental Conservation in development of that agency's Recycling Emblems Program. If the cost of a recycled product does not exceed the cost of a product made without recycled content by 10% (or 15% if over 50% of the recycled materials are generated from the New York State waste stream), the recycled product must be purchased.

M. Omnibus Procurement Act of 1992

It is the policy of New York State to maximize opportunities for the participation of New York State business enterprises, including minority and women-owned business enterprises as Bidders, subcontractors and suppliers on its procurement contracts. Information on the availability of New York State subcontractors and suppliers and a directory of minority and women-owned business enterprises is available from: NYS Empire State Development, 625 Broadway, Albany, New York 12207, email esd@empire.state.ny.us, website <http://www.empire.state.ny.us/>.

N. Restrictions on the Activities of Current and Former State Officers and Employees

Contractors and their employees are cautioned that the hiring of former state employees may violate the Ethics Law. The governing provisions are set forth in Paragraphs 73 and 74 of the Public Officers Law, and the underlying principle of the law is to prevent conflicts of interest, and encourage ethical behavior. The law may be found on the following web site: <http://www.jcope.ny.gov/law/ethics.html>.

While the two most relevant paragraphs of law are contained below, any questions relating to interpretation of the Public Officers Law should be directed to the Ethics Commission at (518) 432-8207 or (800) 873-8442 {(800) 87-ETHIC}.

Public Officers Law Paragraph 73(8)(a)(i) and (ii):

73. 8. (a) (i) No person who has served as a state officer or employee shall within a period of two years after the termination of such service or employment appear or practice before such state agency or receive compensation for any services rendered by such former officer or employee on behalf of any person, firm, corporation or association in relation to any case, proceeding or application or other matter before such agency.

73. 8. (a) (ii) No person who has served as a state officer or employee shall after the termination of such service or employment appear, practice, communicate or otherwise render services before any state agency or receive compensation for any such services rendered by such former officer or employee on behalf of any person, firm, corporation or other entity in relation to any case, proceeding, application or transaction with respect to which such person was directly concerned and in which he or she personally participated during the period of his or her service or employment, or which was under his or her active consideration. Former State employees may be retained by a Contractor under contract with a state agency, after he or she leaves State service, provided that they are not placed back at their former agency during their two year postemployment period or engaged in any other activities that would violate the lifetime bar provision of Public Officers Law Paragraph 73(8)(a)(ii). An individual who, following a hearing, is found to have knowingly and intentionally violated the provisions of Public Officers Law Paragraph 73(8)(a)(i) may be subject to a civil penalty in an amount not to exceed ten thousand dollars (\$10,000.00) for each violation.

O. Determination of Vendor Responsibility

New York State procurement law requires that State agencies award contracts only to responsible contractors. Additionally, the Comptroller must be satisfied that a proposed contractor is responsible before approving a contract award under Section 112 of the State Finance Law. Section 163 of the State Finance Law (SFL) requires that contracts for services and commodities be awarded on the basis of lowest price or best value “to a responsive and responsible offerer.” Section 163 (9) f of the SFL requires that prior to making a contract award, each contracting agency shall make a determination of responsibility of the proposed contractor.

- a) In accordance with these procurement laws, the PCAC will conduct an affirmative review of vendor responsibility for all organizations or firms with which it conducts business. In doing so, Offerers are required to file the Vendor Responsibility Questionnaire online via the New York State VenRep System or may choose to complete and submit a paper questionnaire. To enroll in and use the VendRep System, see the VendRep System Instructions available at <http://www.osc.state.ny.us/vendrep/index.htm> or go directly to the VendRep System online at <https://portal.osc.state.ny.us>. For direct VendRep System user assistance, the OSC Help Desk may be reached at 866-370-4672 or 518-408-4672 or by email at helpdesk@osc.state.ny.us. Offerers opting to file a paper questionnaire may obtain the appropriate questionnaire from the VendRep website http://www.osc.state.ny.us/vendrep/forms_vendor.htm or may contact SUNY System Administration for a copy of the paper form.
- b) The Contractor shall at all times during the Contract term remain responsible. The Contractor agrees, if requested by the PCAC, to present evidence of its continuing legal authority to do business in New York State, integrity, experience, ability, prior performance, and organizational and financial capacity.
- c) PCAC, at its sole discretion, reserves the right to suspend any or all activities under this Contract, at any time, when it discovers information that calls into question the responsibility of the Contractor. In the event of such suspension, the Contractor will be given written notice outlining the particulars of such suspension. Upon issuance of such notice, the Contractor must comply with the terms of the suspension order. Contract activity may resume at such time as PCAC issues a written notice authorizing a resumption of performance of the Contract.
- d) Upon written notice to the Contractor, and a reasonable opportunity to be heard with appropriate officials or staff, the Contract may be terminated by PCAC at the Contractor’s expense where the Contractor is determined by the PCAC to be non-responsible. In such event, PCAC may complete the contractual requirements in any manner it deems advisable and pursue available or equitable remedies for breach.

P. Sales and Compensating Use Tax Documentation

Pursuant to New York State Tax Law Section 5-a (Chapter 60, Part N, Laws of 2004, and amended Chapter 62, Part L, Laws of 2006), for procurements of \$100,000 and greater, a completed Contractor Certification form ST-220-CA must be collected from Contractors. (Contractors must also forward a completed form ST-220-TD to the NYS Tax Department.) The link to obtain the blank form ST-220-CA is: http://www.tax.state.ny.us/pdf/2006/fillin/st/st220ca_606_fill_in.pdf

Q. State Finance Law §§ 139-j and 139-k

1. a. Prior to the final approval by the Office of the State Comptroller, of the contract for which this solicitation has been issued, an Offerer shall not communicate with PCAC or Purchase College other than with the persons identified in this solicitation as Designated Contacts, or with a person who a Designated Contact has advised the Offerer is also a Designated Contact.
- b. **The Designated Contacts for this RFP are identified on page 1 of this RFP.**
- i. Policy and Procedure of the State University of New York State Finance Law §§139-j and 139-k, enacted by Ch. 1 L. 2005, as amended by Ch. 596 L. 2005, effective January 1, 2011, regulate lobbying on government procurement, including procurements by State University to obtain commodities and services and to undertake real estate transactions.

Generally, the law restricts communications between a potential vendor or a person acting on behalf of the vendor, including its lobbyist, to communications with the officers and employees of the procuring agency designated in each solicitation to receive such communications. Further, the law prohibits a communication (a "Contact") which a reasonable person would infer as an attempt to unduly influence the award, denial or amendment of a contract. These restrictions apply to each contract in excess of \$15,000 during the "restricted period" (the time commencing with the earliest written notice of the proposed procurement and ending with the later of approval of the final contract by the agency, or, if applicable, the State Comptroller). The agency must record all Contacts, and, generally, must deny an award of contract to a vendor involved in a knowing and willful Contact. Each agency must develop guidelines and procedures regarding Contacts and procedures for the reporting and investigation of Contacts. The agency's procurement record must demonstrate compliance with these new requirements.

Accordingly, neither a potential vendor nor a person acting on behalf of the vendor should contact any individual at State University other than the person designated in this solicitation as State University's Designated Contact, nor attempt to unduly influence award of the contract. State University will make a record of all Contacts, and such records of Contact will become part of the procurement record for this solicitation. A determination that a vendor or a person acting on behalf of the vendor has intentionally made a Contact or provided inaccurate or incomplete information as to its past compliance with State Finance Law §§139-j and 139-k is likely to result in denial of the award of contract under this solicitation. Additional sanctions may apply.

A complete copy of the State University of New York Procurement Lobbying Policy and Procedure is available for review at <http://www.suny.edu/sunypp/>.

2. Each Offerer shall submit with its Proposal a written affirmation of its understanding of the State University's procurement lobbying procedures and agreement to comply with such procedures. Please see form B: http://www.suny.edu/sunypp/documents.cfm?doc_id=282
3. Each Offerer shall submit with its Proposal written disclosure as to whether the Offerer has been determined to be non-responsible within the previous four years by reason of having violated NY State Finance Law § 139-j or having intentionally provided false or incomplete information to a Governmental Entity with respect to its compliance with NY State Finance Law §139-j; and certification that the Offerer has provided accurate and complete information with respect to the Offerer's compliance with NY State Finance Law §§ 139-j and 139-k within the previous four years. Please see form C: http://www.suny.edu/sunypp/documents.cfm?doc_id=283

R. Consultant Disclosure Legislation

Chapter 10 of the Laws of 2006 amends State Finance Law §§ 8 and 163 by requiring that contractors annually report certain employment information to the contracting agency, the department of Civil Service (DCS) and Office of the State Comptroller (OSC). As a result of these changes in law, State contractors will be required to disclose, by employment category, the number of persons employed to provide services under a contract for consulting services, the number of hours worked and the amount paid to the contractor by the State as compensation for work performed by these employees This will include information on any persons working under any subcontracts with the State contractor. Contractor will follow all rules and regulations of Consultant Disclosure Legislation requirements. Please see web site <http://www.osc.state.ny.us/agencies/guide/MyWebHelp/> (section XI.18.C). A properly completed Form A, AC 3271-S (must be submitted by successful vendor: www.osc.state.ny.us/agencies/forms/ac3271s.doc).

Form B, Contractor's Annual Employment Report, will be required annually for each period ending March 31.

S. Diesel Emissions Reduction Act of 2006 (the "Act")

The Contractor certifies and warrants that all heavy duty vehicles, as defined in New York State Environmental Conservation Law (ECL) section 19-0323, to be used by the Contractor, its Agents or Subcontractors under this Contract, will comply with the specifications and provisions of ECL section 19-0323 and any regulations promulgated pursuant thereto, which requires the use of Best Available Retrofit Technology ("BART") and Ultra Low Sulfur Fuel ("ULSD"), unless specifically waived by DEC.

Qualification for a waiver under this law will be the responsibility of the Contractor. Annually, but no later than March 1st, the Contractor shall complete and submit directly to the State University of New York ("SUNY"), via electronic mail, the Regulated Entity Vehicle Inventory Form and Regulated Entity and Contractors Annual Report forms at the Department of Environmental Conservation ("DEC") website: <http://www.dec.ny.gov/chemical/4754.html> for heavy duty vehicles used in the performance of this Contract for the preceding calendar year. The Contractor shall certify to SUNY, and submit with each application for payment, the Contractor and Subcontractor Certifications form, which states that the Contractor will comply with the provisions of Section 20.23."

T. Payment Terms

Payments under the resulting contract award shall be made to the Contractor, upon receipt of goods/services and properly approved and completed invoice/s submitted to the attention of PCAC. The Contractor shall provide complete and accurate billing invoices in order to receive payment for its services. Billing invoices to be submitted must contain all information and supporting documentation required by PCAC. Payment for invoices submitted by the Contractor shall only be rendered electronically unless payment by paper check is expressly authorized by the Vice President for Administration or designee, in her/his sole discretion, due to extenuating circumstances. Such electronic payment shall be made in accordance with ordinary New York State procedures and practices. The Contractor shall comply with the OSC procedures to authorize payments. Authorization forms are available at the OSC website at www.osc.state.ny.us/epay/index.htm, by email at epunit@osc.state.ny.us or by telephone at 518-474-4032. The Contractor acknowledges that it will not receive payment on any invoices submitted under this contract if it does not comply with the OSC's electronic payment procedures, except where the Vice President or designee has expressly authorized payment by paper check as set forth above.

Payment shall be made net 30 days from receipt of an acceptable invoice. Interest for any unpaid balance will accrue pursuant to Section 179g of the New York State Finance Law that is 30 days past receipt of a SUNY acceptable invoice.

U. Information Security Breach and Notification Act

Contractor shall comply with the provision of the New York State Information Security Breach and Notification Act (General Business Law Section 899-aa and State Technology Law, Section 208). Contractor shall be liable for the costs associated with such breach if caused by Contractor's negligent or willful acts or omissions, or the negligent or willful acts or omissions of Contractor's agents, officers, employees or subcontractors.

V. Iranian Divestment Act of 2012

As a result of the Iran Divestment Act of 2012 (Act), Chapter 1 of the 2012 Laws of New York, a new provision has been added to the State Finance Law (SFL), § 165-a, effective April 12, 2012. Under the Act, the Commissioner of the Office of General Services (OGS) is charged with developing a list (prohibited entities list) of "persons" who are engaged in "investment activities in Iran" (both are defined terms in the law). Pursuant to SFL § 165-a(3)(b), the initial list is expected to be issued no later than 120 days after the Act's effective date, at which time it will be posted on the OGS website.

The successful Bidder (or any assignee) certifies that once the prohibited entities list is posted on the OGS website, it will not utilize on the contract to be awarded pursuant to this RFP any subcontractor that is identified on the prohibited entities list. Additionally, the successful Bidder agrees that after the list is posted on the OGS website, should it seek to renew the Contract, it will be required to certify at the time the Contract is renewed or assigned that it or its assignee is not included on the prohibited entities list.

During the term of the Contract to be awarded pursuant this RFP, should PCAC receive information that the successful bidder is in violation of the above-referenced certification, SUNY will offer the successful bidder an opportunity to respond. If the successful bidder fails to demonstrate that it has ceased its engagement in the investment which is in violation of the Act within 90 days after the determination of such violation, then PCAC shall take such action as may be appropriate including, but not limited to, seeking compliance, recovering damages, or declaring the successful bidder to be in default.

PCAC reserves the right to reject any request for assignment for an entity that appears on the prohibited entities list prior to the award of a contract, and to pursue a responsibility review with respect to any entity that is awarded a contract and appears on the prohibited entities list after contract award.

W. Additional Terms and/or Conditions:

1. The following items will be incorporated into, and made part of, the formal agreement: (1) PCAC's RFP; (2) the Successful Offerer's Proposal; (3) Exhibit A, Standard Contract Clauses; (4) Exhibit A-1, Affirmative Action Clauses.

2. In the event of any inconsistency in or conflict among the document elements of the agreement described above, such inconsistency or conflict shall be resolved by giving precedence to the document elements in the following order: (1) Exhibits A and A-1; (2) the Agreement; (3) this RFP; and (4) the Successful Offerer's Proposal.
3. Any terms that are attached or referenced with a submission shall not be considered part of the bid or proposal, but shall be deemed included for informational purposes only.
4. The resulting agreement shall be binding upon its execution by both parties and, upon the approval of the Division of the Budget, Attorney General and the Office of the State Comptroller.
5. The agreement may be revised at any time upon mutual consent of the parties in writing. Such written consent will not be effective until signed by both parties and, if required, by New York State law, approved by the Division of the Budget, Attorney General and the Office of the State Comptroller.
6. The relationship of the Successful Offerer to PCAC shall be that of independent prime contractor.
7. Compliance with the post-employment restrictions of the Ethics in Government Act is required.
8. Proposed prices should reflect all discounts including educational discounts. Price reductions are encouraged and acceptable at any time during the contract period.
9. The submission of a Proposal constitutes a binding offer to perform and provide said services. Such binding offer shall be firm and not revocable for a period of 180 days after the deadline for Proposal submission and will continue thereafter until the Successful Offerer notifies PCAC otherwise, in writing. Such deadline may be further extended by mutual agreement.
10. In the event Successful Offerer uses partners, subcontracts or subcontractors, the Successful Offerer will remain responsible for compliance with all specifications and performance of all obligations under the contract resulting from this RFP. For the resulting agreement, the Successful Offerer will be the prime contractor.
11. PCAC will not be liable for any costs associated with the preparation, transmittal, or presentation of any Proposals or materials submitted in response to this RFP or the costs of any services performed prior to receiving approval of the agreement from New York State. All Proposals and materials submitted in conjunction with Proposals shall become the property of PCAC for use as deemed appropriate, respecting all copyrights.
12. PCAC will be the interpreter of all contract documents and make the final determination of the intent and meaning of all contract documents including the vendor's bid proposal. PCAC shall be the determinant and make the final determination.
13. This RFP and the resulting contract shall be governed by the Laws of the State of New York.
14. Public announcements or news releases regarding this RFP or any subsequent award of a contract must not be made by any Offerer without the prior written approval of PCAC.
15. The Successful Offerer(s) is responsible for compliance with all applicable rules and regulations pertaining to cities, towns, counties and State where the services are provided, and all other laws applicable to the performance of the resulting contract. The Successful Offerer shall provide all necessary safeguards for safety and protection as set forth by the United States Department of Labor, Occupational Safety and Health Administration.
16. Indemnification - The Successful Offerer shall hold harmless and indemnify PCAC, Purchase College, the State University of New York and the State of New York, their officers and employees from and against any injury, damage, loss or liability to persons or property resulting from or arising out of (a) the agreement, and (b) the acts, omissions, liabilities, or obligations of the Successful Offerer, any affiliate, or any person or entity engaged by the Successful Offerer as an expert, consultant, independent contractor, subcontractor, employee or agent.
17. Liability - The Successful Offerer will be responsible for the work, direction and compensation of its employees, consultants, agents and contractors. Nothing in the resulting agreement or the performance thereof by the Successful Offerer will impose any liability or duty whatsoever on PCAC, Purchase College and/or the State University of New York including, but not limited to, any liability for taxes, compensation, commissions, Workers' Compensation, disability benefits, Social Security, or other employee benefits for any person or entity.
18. Liability Insurance –Prior to the commencement of work, the Successful Offerer will provide, at its sole cost and expense, Certificates of Insurance which shall remain in force throughout the term of the agreement, or any extension thereof, from an

insurance company authorized to do business in the State of New York with a combined liability insurance policy with limits no less than Three Million Dollars (\$3,000,000) per individual for bodily injury and no less than Five Million Dollars (\$5,000,000) for property damage. Such policies shall name PURCHASE COLLEGE ADVANCEMENT CORPORATION, and co-name PURCHASE COLLEGE, the STATE UNIVERSITY OF NEW YORK and the STATE OF NEW YORK as additional insured (in the case of fire insurance, as its insurable interest may appear). Such policy shall designate PCAC, as the loss payee and shall contain a provision that PCAC shall receive at least thirty (30) days' notice prior to material change, cancellation or expiration of any such policy. The certificates of such insurance should be delivered to: *Director of Purchasing & Accounts Payable, Purchase College, State University of New York, 735 Anderson Hill Road, Purchase, NY 10577-1402*. Contractor will be responsible to submit updated certificates throughout the duration of the contract term. When possible please send certificates electronically or via fax. Each Certificate must include the specific Contract number and the name of the Contract Officer. Contractor is required to obtain any permits, insurance, bonds, etc., normally required for his/her business and employees.

Each insurance carrier must be rated at least "A-" Class "VII" in the most recently published Best's Insurance Report. If during the term of the policy, a carrier's rating falls below ""A-" Class "VII", the insurance must be replaced no later than the renewal date of the policy with an insurer acceptable to The State University of New York and rated at least "A-" Class "VII" in the most recently published Best's Insurance Report. The Contractor shall require that any subcontractors hired, carry insurance with the same limits and provisions provided herein.

19. Workers Compensation Insurance & Disability Benefits Coverage - All employees in the hire of the Successful Bidder shall be adequately and properly covered by Workers' Compensation Insurance and Disability Benefits coverage in all work concerned in and about the Purchase College premises. Prior to commencement of work, proof of coverage of Workers Compensation Insurance and of Disability Benefits Coverage will be required to be submitted. For further information, see <http://www.wcb.ny.gov/content/main/Employers/busPermits.jsp>.
20. Any firm or individual that participated in the development or preparation of this RFP is not eligible for award of the resulting contract.

X. PCAC has the right to:

1. Reject any and all Proposals received in response to this RFP in part or entirely.
2. To terminate any resulting contract in the event it is found that the certification filed by the Contractor in accordance with New York State Finance Law § 139-j and 139-k was intentionally false or intentionally incomplete. Upon such finding, PCAC may exercise its termination right by providing written notification to the Contractor in accordance with the written notification terms of the contract.
3. Request certified audited financial statements for the past three (3) completed fiscal years and/or other appropriate supplementation including, but not limited to, interim financial statements and credit reports.
4. Request references and to contact any or all references.
5. Waive requirements or amend this RFP upon notification to all Offerers. Mandatory requirements may be eliminated if unmet by all Offerers.
6. Adjust or correct cost or cost figures with the concurrence of the Offerer if mathematical or typographical errors exist.
7. Negotiate with Offerers responding to this RFP within the requirements necessary to serve the best interests of PCAC.
8. PCAC reserves the right to change any dates specified for the review and selection process.
9. Begin contract negotiations with another Offerer in order to serve the best interests of PCAC, should PCAC be unsuccessful in negotiating a contract with the Successful Offerer within an acceptable time frame.
10. Request clarifications from Offerers for purposes of assuring a full understanding of responsiveness, and further to permit revisions from all Offerers determined to be susceptible to being selected for contract award, prior to award.
- 11.

Waive minor irregularities.

12. PCAC reserves the right to modify or amend the requirements of this RFP after its release. All vendors will receive written notification of any modifications to the requirements of this RFP. If any modifications make compliance with the original Procurement Timetable impractical, the PCAC will adjust the timetable accordingly.
13. Vendors who submit a Proposal in response to the RFP may be required to give an oral presentation to representatives of PCAC and/or allow a site visit to the main or branch office. The site visit may include a demonstration of on-line inquiry access services. This shall provide an opportunity for the Vendor to clarify or elaborate on the Proposal, but shall in no way change the original Proposal. PCAC shall schedule the time and location.
14. The successful vendor will be notified by the PCAC by telephone and confirmed by letter.
15. By submitting a Proposal, the vendor agrees that she/he will not make any claims for or have any right to damages because of any misinterpretation or misunderstanding of the specifications or because of any misinformation or lack of information.
16. Vendors may be requested to provide evidence that the award of an Agreement will not result in a conflict of interest with regard either to other work performed by the vendor or to potential conflict of interest among vendor staff.
17. Omissions, inaccuracy or misstatements may be sufficient cause for rejection of the Proposal.
18. PCAC reserves the right to reject any or all portions of any offer, to negotiate terms and conditions consistent with the solicitation, and to make an award for any or all remaining portions.
19. Subcontractors
 - Except for vendors designated by the PCAC, the vendor must, in their Proposal response, indicate the name and address of all proposed subcontractors. This statement must contain a description of the portion of the work which the proposed subcontractors are to perform/provide and any information tending to prove that the proposed subcontractors have the necessary skill, experience and financial resources to provide the service in accordance with the RFP.
 - The vendor shall have sole responsibility to the PCAC for the acts or defaults of said subcontractors, of such subcontractor's officers, agents and employees, each of whom shall for this purpose, be deemed to be the agent or employee of the vendor to the extent of its subcontract.
 - The vendor shall execute with each of its subcontracts and shall require all subcontracts to execute a written agreement which shall bind the latter to the terms and provisions of this Request for Proposals insofar as such terms and provisions are applicable to the work to be performed by such subcontractors.

PART II: DETAILED SPECIFICATIONS

Table of Contents

Section	Page
1. Introduction and Overview.....	10
2. Pre-Proposal Conference.....	12
3. Project Vision, Components and Marketing and Operational Requirements.....	13
4. Site Characteristics and Conceptual Plans.....	15
5. Design and Performance Criteria.....	17
6. Structures of Contracts and Scopes of Services.....	19
7. Submission Requirements.....	22
8. Proposal Evaluation Criteria.....	25
9. Proposal Evaluation and Selection Process.....	27

1. Introduction and Overview

- 1.1. A unique opportunity exists to create a vibrant senior learning community on the campus of Purchase College, State University of New York. The residents of this community will be able to enjoy the many amenities of the college including the renowned Neuberger Museum of Art and the Performing Arts Center, the athletic facilities and the park-like campus. Additionally, residents will be able to avail themselves of many of the varied educational opportunities. They will be able to enjoy all of these benefits while living on the campus in a village designed specifically for their needs and lifestyle.
- 1.2. Purchase College, a public four-year college of arts and liberal arts and sciences, was founded in 1967 and is one of the thirteen comprehensive colleges of the State University of New York (SUNY) system. Purchase College accepted its first continuing education students in 1968, its first matriculated students as Juniors in 1971, and held its first commencement in 1973.

The campus, located on more than 500 acres in Westchester County, just 25 miles north of New York City, includes the Neuberger Museum of Art and the Performing Arts Center. The College currently enrolls approximately 4200 students, with 65% of the students in liberal arts and sciences programs and 35% in conservatory programs in the arts. Purchase College has seen a dramatic increase in the number of students living on campus, with approximately 92% of the entering freshmen and 67% of all matriculated undergraduate students residing on campus.

Purchase College is unusual among public institutions as it combines both renowned and highly selective professional and conservatory arts programs with distinguished liberal arts and sciences programs on a single campus and in one college, in accordance with its mission statement. The largest programs are in Visual Arts, Music, Liberal Studies, Psychology, Dance, Biology, Journalism, and New Media. Recent initiatives have led to significant increases in programs such as Sociology and Graphic Design and to new programs including Bachelors of Arts in Arts Management, Playwriting and Screenwriting, and Theatre and Performance, and a Bachelor of Science in Visual Arts. With the exception of Liberal Studies, where seniors complete a one-semester capstone project, all students complete a two-semester senior project in which they work one-on-one with a member of the faculty in their major area of study.

Purchase College has a large and diverse continuing education program. In addition to administering a Bachelor of Arts degree completion program in Liberal Studies designed for adults and transfer students, the School of Liberal Studies and Continuing Education (LCSE) serves over 200 non-matriculated students each semester and administers the college's summer sessions. LCSE also provides non-credit classes for the students and the neighboring community. Additionally, Purchase College offers fully accredited Masters Programs in select fields.

Purchase College promotes life-long learning for students of all ages, backgrounds, and incomes, and makes many of its resources available to the broader community. Purchase College presents the visual and performing arts through exhibitions and performances at the Neuberger Museum of Art and at the Performing Arts Center, as well as in other performance and exhibition spaces around the campus, and offers opportunities for intellectual growth through numerous free lecture series.

Finally, Purchase College provides a broad range of opportunities for senior citizens, including an auditing program in the academic sector, a trained docent program at the Neuberger Museum of Art, and opportunities for volunteering in the educational outreach program of the Performing Arts Center.

- 1.3. Purchase College Advancement Corporation, a New York State not-for-profit corporation (“PCAC”), desires to contract for certain services related to the design, development, construction, operation, management and financing of a senior learning community (“SLC”) on a 40.05 acre parcel of land within the existing campus of Purchase College, State University of New York, in the Town/Village of Harrison, Westchester County, New York (the “College”). The purpose of this Request for Proposals (the “RFP”) is to identify the most qualified respondent to enter into negotiations, and to eventually execute a contract for operations management services. Two other RFP’s are being issued simultaneously with this RFP – one to contract for a development consultant of the SLC and one to contract for investment banking services. Scopes of work, submission requirements and evaluation criteria for each of the other services is included, herein, for informational purposes.
- 1.4. PCAC is a not-for-profit corporation formed specifically for this project. The corporation is governed by a Board of Directors (the “Board”)
- 1.5. PCAC has been granted the right to lease the subject 40.05 acre parcel (the “Parcel”) for an initial term of 40 years by the New York State Legislature in Bill No. A00340A, made effective on August 18, 2011 (Chapter 405 of the Laws of 2011), for the purposes described (the “Bill”), included herein as Attachment 2.
- 1.6. The Bill allows for the development, construction, operation and management of a senior learning community, comprised of up to 385 dwelling units and related facilities, on the parcel. Of these units, 20% must be made available for occupancy of residents whose income is less than or equal to 80% of the median income of Westchester County, New York.
- 1.7. There are other provisions within the Bill, some of which are enumerated in more detail within this RFP. Respondents should carefully review the Bill to be certain of their willingness and ability to comply with all of its terms.
- 1.8. PCAC has researched similar projects, has contracted for a preliminary market study, has contracted for the completion of certain preliminary due diligence, and has discussed at length with personnel of the College, the desired scope and nature of the proposed facility.
- 1.9. It is the opinion of PCAC that the preliminary market study shows that the project is highly feasible and that there is a substantial depth of market, particularly among seniors within the younger, more active cohorts. Further market studies will likely be required.
- 1.10. The PCAC intends to provide a facility in which its residents will actively participate in many aspects of the college experience. It envisions a vibrant, active senior population with a strong desire to become an integral part of the college’s life and culture. Residents will be expected to participate as members of the Neuberger Museum and/or subscribers to the Performing Arts Center.
- 1.11. It is the intent of PCAC to enter into contracts with qualified firms to provide for certain services related to the project including management of the development and initial marketing of the project (hereafter referred to as the “Development Consultant”), management of the operations of the facility (hereafter referred to as the “Operator”, and services related to the initial, intermediate and long-term financing of the project (hereafter referred to as the “Investment Banker”). PCAC recognizes that certain firms may choose to respond to more than one of the three RFP’s that have been simultaneously issued. PCAC encourages this, if the responding firm has the requisite capabilities. Each response to an RFP shall be separately submitted and will be evaluated separately. Requirements for qualified responses, selection criteria and process, as well as anticipated contract elements are further detailed in Sections 6 through 9 of the Detailed Specifications. Other services, such as professional design services and construction services, will be contracted directly with PCAC, separately, pursuant to future RFP’s and with the guidance of the Development Consultant, Operator and Investment Banker.
- 1.12. The net proceeds from the project will be used, in accordance with the requirements of the Bill, to provide for additional student scholarships and for the acquisition of new, full-time college faculty.

End of Section 1

Pre-Proposal Conference

- 2.1. There will be a non-mandatory Pre-Bid Proposal meeting from 10:00 am until 4:00 pm on the date indicated on page 1 in the Calendar of Events - Procurement Timetable in the Student Services Building, Conference Room 0129 (the “Red Room”) at Purchase College, State University of New York, 735 Anderson Hill Road, Purchase, New York 10577. The purpose of this meeting is to allow potential respondents an opportunity to present questions, to obtain clarification relative to any facet of this solicitation, and to tour both the project site and the college facilities. Attendees wishing to walk the mostly wooded project site should dress appropriately. This Pre-Bid Proposal meeting will be held collectively for the three RFP’s discussed in Section 1.11 of this detailed specification. Respondents should refer to the Calendar of Events - Procurement Timetable for additional scheduling information. Please email wayne.rush@purchase.edu with your intentions to attend this meeting by Monday, October 28, 2013 so that arrangements can be made for space, lunch and refreshments.
- 2.2. While attendance at this meeting will not be a prerequisite to submitting a proposal, respondents are strongly encouraged to attend.

End of Section 2

3. Project Vision, Components, and Marketing and Operational Requirements

- 3.1. **Vision.** As stated in the Introduction and Overview, the College and PCAC desire to enter into a series of contracts with experienced and reputable firms for the management of the design, project approvals, construction, marketing, operations, and financing of a senior learning community consisting of up to 385 units of senior housing and related facilities.
- 3.1.1. The project should be developed and operated in a manner consistent with cutting edge examples of other “college related retirement communities” in which the senior living component has been successfully integrated into the life and culture of the college campus.
- 3.1.2. Purchase College and PCAC wish to provide a facility in which the residents are actively engaged in many aspects of the college. They envision residents participating in activities of the renowned Performing Arts Center and Neuberger Museum of Art and will expect residents to be active members of at least one of these organizations. The College also anticipates residents participating in many of the academic activities. The College may deliver some academic courses at the facility. It also envisions residents utilizing the other facilities of the college including its athletic facilities, walking paths and the extensive campus grounds. The College also desires that the senior population will provide support to the younger students in the form of mentoring, tutoring, guest lecturing, and other activities.
- 3.1.3. The College and PCAC envision a vibrant, active senior population with a strong desire to become an integral part of the college’s life and culture. Every aspect of the design, development, operation and management of the facility should seek to achieve this vision. Consideration should be given during the design of the project to provide for easy and inviting access to campus facilities and activities. Provisions should also be made for students to access the SLC including facilities such as carrels for student/resident interaction. The marketing program for the project should target those individuals that will be most likely to participate in college activities. And, the operational program should clearly and purposely encourage participation in college activities. These aspects of the project are discussed in more detail in the Design and Performance Criteria section of the Detailed Specifications.
- 3.2. **Components.** The successful respondents to the three RFP’s enumerated in Section 1.11, collectively, will be expected to provide all of the resources and expertise necessary to manage the design, project approvals, construction, marketing, operations and financing of the facility to realize these goals.
- 3.2.1. The SLC facility will consist of up to 385 units of senior housing. These units may be in the form of apartments and/or single family attached or detached homes designed and intended for occupancy by seniors. The inclusion of units intended for higher levels of health care for residents such as assisted living and/or skilled nursing may also be appropriate, but neither is a required element for submission of a proposal. PCAC prefers not to have skilled nursing facilities within the facility, but will consider if the awardees feel it is vital to the marketing and/or operations of the community. The project may be phased in order to anticipate an expected absorption rate.
- 3.2.2. In accordance with the Bill, a minimum of 20% of these units shall be available for, and occupied by individuals or families whose income is at or below 80% of the current median income in Westchester County, New York. Priority for the occupancy of 50% of these affordable units shall be given to existing residents of the county.
- 3.2.3. The SLC facility may also include common areas for use by the residents including, but not limited to, dining facilities, lounge areas, fitness facilities, retail facilities, classrooms, carrels, crafts rooms, and beauty and spa facilities. These common areas may also be made available to students, faculty and staff of the College.
- 3.2.4. The SLC facility will also include all of the site work and infrastructure improvements necessary to service the facility.
- 3.2.5. As a component of the site work and infrastructure improvements, the project will need to satisfy all of the requirements of the New York Department of Environmental Conservation (NYDEC) related to the mitigation and closure of an unlicensed construction debris area within the bounds of the lease parcel, further detailed in Section 4. This area shall be successfully integrated into the design of the facility including, but not limited to, the creation of passive and active recreation areas and pedestrian and vehicular circulation.
- 3.2.6. The SLC facility will be expected to be designed and constructed utilizing high quality materials and workmanship by well qualified and reputable design professionals and contractors.

- 3.2.7. The College will enforce strict adherence to a set of Design and Performance Criteria, further discussed in this RFP, to be negotiated and detailed, which will become a part of the awarded contracts.
- 3.2.8. Access easements, utility easements, utility sharing agreements, covenants and restrictions, licensing agreements, shared services agreements and other documents necessary for the development and operation of the facility may be necessary as a part of the series of contracts contemplated for the project.
- 3.3. **Marketing and Operational Requirements.** The Development Consultant and the Operator will be required to adhere to marketing and operational programs specifically designed and intended to realize the described vision of the project.
 - 3.3.1. The College enjoys an excellent reputation for providing a high quality liberal arts education centered on the arts and sciences. The College attracts talented students aspiring to pursue studies in music, performing and creative arts, visual arts, and other traditional liberal arts studies. The Performing Arts Center and the Neuberger Museum of Art further enhance this reputation and are also coveted assets in the local and regional community.
 - 3.3.2. Purchase College intends to partner with the Development Consultant and the Operator to leverage the reputation and assets of the College so that the proposed SLC will attract and retain those with similar affinities and interests.
 - 3.3.3. The Development Consultant and the Operator will be expected to create and refine, from time to time, a marketing program designed to attract senior residents that will embrace and participate in the academic and artistic environment of the College. This program will be memorialized in the Performance and Design Criteria and become a part of the contracts and agreements.
 - 3.3.4. Similarly, the operations and management of the community should encourage participation by the residents in the college's academic and cultural activities. The Development Consultant and the Operator will be expected to create, refine and operate specific programs designed to accomplish this.

End of Section 3

4. Site Characteristics and Conceptual Plans

- 4.1. **Site Characteristics.** The site consists of a 40.05 acre tract of land within the Purchase College, SUNY campus in Purchase, New York. The campus is located at 735 Anderson Hill Road, approximately two miles north of I-287 in southeastern Westchester County. To the south of the campus, on the opposite side of Anderson Hill Road is the world headquarters for PepsiCo. The Old Oaks Country Club is to the west of the campus. The campus is bordered to the east by residential housing and by the Doral Arrowwood Resort. The Westchester County Airport is directly north of the campus. A vicinity map is included as Attachment 3.
- 4.1.1. Refer to Attachment 4 for aerial maps and topographic surveys of the parcel. Some planning work has been completed and is included in Attachment 7. The planning work should be considered informational and non-binding. The 40.05 acre parcel is bordered by Brigid Flanigan Drive to the west and south, by the college administration and human resources offices to the north and by a narrow strip of land adjacent to Lincoln Avenue to the east. Within the 40.05 acre parcel there are three distinct areas. The northernmost section is approximately 12 acres, slopes gently from north to south and is mostly wooded. The next section of the property to the south is approximately 15 acres. It contains approximately 300,000 cubic yards of construction and demolition debris (“C & D”) that was placed there by an outside contractor over a several year period from 1999 through 2004. This area is considered by the NYDEC to be an unlicensed C & D landfill. More description of this area is included later in this section. The southernmost section of the property is approximately 13 acres, slopes gently from north to south and is entirely wooded. There are no building structures within the lease area. There may be underground utilities that will need to be preserved and/or relocated. There are several art sculptures within the lease area that will need to be incorporated into the design or relocated to a location acceptable to the College.
- 4.1.2. The unlicensed C & D landfill has been the subject of action by NYDEC. In April, 2001, an Order of Consent was executed by NYDEC, Purchase College and the original contractor that prescribed specific requirements for the proper closure of the landfill by the contractor. Further correspondence between the College and NYDEC occurred in 2004 that sought to amend the original order. Respondents should refer to the Preliminary Geotechnical and Environmental Engineering Report prepared by SESI Consulting Engineers, PC and dated December 14, 2012, included herein as Attachment 6. Additional documentation is available upon request.
- 4.2. **Conceptual Plans.** As previously described, the project consists of the design, development, construction, operation and management of up to 385 units of senior housing, with related services and amenities. As a required element of a proposal submitted relative to this RFP, further detailed in subsequent sections, the respondents shall indicate, if appropriate and in general, intended concept plans and, more specifically, the intended mix of units. Consideration should be given to the inclusion of some units offering higher levels of healthcare (assisted living and/or skilled nursing), but neither is a required element for submission of a proposal. The respondents will be required to work with the PCAC and the College to fully develop a plan that is satisfactory to all parties.
- 4.2.1. PCAC has retained consultants to perform certain due diligence related to the development of the project. The due diligence includes investigations regarding the availability and capacity of utilities, the location of wetlands and other site constraints, and the identification of requirements such as storm water management facilities. A memorandum from Divney Tung Schwalbe, LLP, dated December 19, 2012, included herein as Attachment 5, discusses utility availability for the project and other engineering related criteria. Additional due diligence will be required.
- 4.2.2. PCAC intends to begin preparation and processing the Draft Environmental Impact Statement (DEIS) in accordance with the requirements of the State Environmental Quality Review Act (SEQRA). Purchase College, SUNY, will act in the capacity of Lead Agency in the processing of this requirement. The DEIS will be prepared based on preliminary concept plans. The expectation is that the approved Final Environmental Impact Statement (FEIS) will either be based on these plans with language requiring that final development plans shall be consistent with the scope and intent of these plans, or that specific development plans will have been prepared and submitted in their stead.
- 4.2.3. Similarly, PCAC has retained SESI Consulting Engineers, PC and MKW Associates, Landscape Architects, to work with NYDEC in developing an approved resolution to the issues pertaining to the unlicensed C & D landfill. PCAC anticipates cooperation from NYDEC in resolving these issues. The landfill area shall be integrated into the development in a meaningful and useful manner. The use of this area as passive and active open space for the residents is encouraged.

- 4.2.4. As previously stated, it is required that the SLC will be integrated into the activities and culture of the college. The awardees will be expected to work cooperatively with the PCAC and the College, as appropriate to the scope of work provided, to develop a comprehensive program for the physical and operational integration of the SLC with the college. This will include provisions for improvements for pedestrian access to the facilities of the college and for the development and execution of programmatic elements that will create incentives for the senior population to avail themselves of educational and cultural activities of the college.

End of Section 4

5. Design and Performance Criteria

- 5.1. **Design.** As an element of the final agreements between the Development Consultant, the Operator, PCAC and the College, a comprehensive set of design and performance criteria, some of which are set forth below, will be developed, negotiated and agreed upon. These will include a procedure for the submission, review and approval of all design plans for the project.
- 5.1.1. The scope of the approvals will include sign-offs on site plans, landscape plans and architectural plans, including the choice and use of materials and compatibility with the vernacular of the existing campus and with the surrounding area.
 - 5.1.2. The mix of unit types has not been specified in these RFP's. If appropriate, respondents should indicate a preliminary proposed unit mix. Consideration should be given to the inclusion of some units offering higher levels of healthcare (assisted living and/or skilled nursing), but neither is a required element for submission of a proposal. PCAC prefers not to have skilled nursing facilities within the facility, but will consider if the awardees feel it is vital to the marketing and/or operations of the community.
 - 5.1.3. The facility should be designed with a strong sense of community and a "village" feel.
 - 5.1.4. The maximum height of any building shall be four stories plus one partially buried level of parking underneath.
 - 5.1.5. Buildings should be set back from Brigid Flanigan Drive a minimum of thirty feet from the curb line for buildings two stories in height or less. Buildings over two stories should be set back a minimum of fifty feet. Parking areas should be set back a minimum of twenty feet from the buildings and roads, and should be adequately screened with landscape material.
 - 5.1.6. Consideration should be given to maintaining a wooded buffer along Brigid Flanigan Drive.
 - 5.1.7. The main entrance area should be appropriately designed with plentiful landscape material and a strong sense of arrival. The existing natural stone walls should be preserved and enhanced, to the extent practical.
 - 5.1.8. The existing East-West Road is not a public road. It is not necessary or desirable to retain this roadway within the proposed development.
 - 5.1.9. Exterior materials of buildings shall be brick, stone (natural or cultured) and/or cementitious siding (Hardi-Plank or equal), unless other materials are approved by PCAC.
 - 5.1.10. Landscaping shall be substantial and consistent with the high quality of the building architecture. Sufficient screening of foundations, parking and loading areas shall be included.
 - 5.1.11. The project shall be designed, permitted and constructed consistent with applicable SUNY Program Directives, including appropriate environmental and sustainability initiatives. Technical review of construction plans and specifications will be conducted by a third party reviewer on behalf of the College. Construction permits and certificates of occupancy will be issued by the College, upon recommendation of third party reviewers and inspectors. Because this is a project furthering the mission of the college, municipal construction officials will not have jurisdiction over the design or construction of the project and the project will not be required to obtain local zoning and site plan approvals. Other approvals, such as compliance with SEQRA, discussed in Section 4.2.2, will be required.
- 5.2. **Performance Criteria.** The project agreements shall include a comprehensive set of performance criteria, including procedures for verification of compliance. The criteria shall be negotiated and mutually agreed upon by all parties prior to final execution of contracts.
- 5.2.1. As previously stated, performance criteria enforcing the design and construction quality of the project will be developed.
 - 5.2.2. Performance criteria for the Operator shall also include periodic assessment of resident health, welfare, and satisfaction. This assessment shall be administered by an independent auditor. The contract agreements shall provide for PCAC to replace the Operator in the event that results of the audit fall below the minimum prescribed levels for more than one assessment period.

- 5.2.3. Performance criteria shall also be developed to assess the project's effectiveness of integrating with the College and providing for an environment of learning and cultural engagement. This shall consist of an annual reporting and audit of resident participation in college programs. The agreements shall provide for the replacement of the Operator for continued unsatisfactory levels of resident participation.
- 5.2.4. Buildings and grounds shall be maintained in good condition. Maintenance and capital replacement plans shall be prepared by the Development Consultant and the Operator and agreed upon by PCAC prior to the execution of agreements. These plans shall be incorporated into the final agreements.

End of Section 5

6. Structures of Contracts and Scopes of Services

- 6.1. **PCAC.** Pursuant to the RFPs, PCAC intends to issue contracts for three elements of work related to the project, as follows: Development Consultant, Operator, and Investment Banker. Summaries of the scopes of services for these contracts are included herein. Respondents may choose to offer to provide services related to more than one of the scopes of services by submitting separate proposals in accordance with the appropriate RFP.
- 6.1.1. In the anticipated structure, PCAC will be the “owner” and “sponsor” of the SLC. PCAC will contract with the Development Consultant, will contract with the Operator, and will be the obligor of the initial and permanent financing for the project. Residence and Care Agreements will be executed between the residents of the SLC and PCAC.
 - 6.1.2. Certain services will be provided to the SLC in separate contracts with the College for such items as security, technology services and educational services. The form of those contracts will be “cost-plus-a-fee”. A revocable licensing agreement requiring a yearly fee, in which the College allows for the use of its name and certain symbols, may also be included.
 - 6.1.3. The revenue for the project will consist of fees for rent and services, and may also include the non-refundable portion of entrance fees. The net proceeds from the project will be used, in accordance with the requirements of the Bill, to fund additional student scholarships and for the acquisition of new, full-time college faculty.
 - 6.1.4. PCAC recognizes that the project will most likely be developed in multiple phases. **Respondents should assume the first phase of the project to be approximately 200 units. Responses should reflect this scope of work**, with some discussion regarding how future phases could be accommodated through the extension of contracts or by other means.
- 6.2. **Operator.** PCAC intends to retain an Operator, who has a proven record of success in managing all aspects of similar facilities, in a long term, renewable contract to manage the community. The Operator will have overall responsibility for the management of the SLC and for the provision of goods and services related to the health, welfare and daily living needs of its residents.
- 6.2.1. The Operator will provide a full time management team, whose members are approved from time to time by PCAC, at the property. All other personnel will be employees of PCAC and managed by the Operator.
 - 6.2.2. The Operator will be responsible for attaining and maintaining all permits, licenses, certificates of authority and/or certificates of need that are required to operate the facility, with the exception of the initial project approvals, building permits and certificates of occupancy, which will be the responsibility of the Development Consultant. Additionally, if applicable, the Operator will process all local, state and federal forms required for the disbursement of funds related to the residents’ care.
 - 6.2.3. The Operator will create and refine, from time to time, a Residence and Care Agreement that is approved by PCAC.
 - 6.2.4. The Operator will be responsible to manage the SLC on a daily basis and to provide for the daily needs of the residents consistent with the mission and vision, as described in this RFP.
 - 6.2.5. The Operator will be responsible for the sales and marketing efforts of the community after initial stabilized occupancy has been attained. The Operator and the Development Consultant shall execute an orderly transition of the sales and marketing activities and responsibilities when initial stabilized occupancy has been attained.
 - 6.2.6. The Operator will negotiate and manage contracts for all vendors of services and supplies for the SLC. Contracts will be executed between PCAC and each vendor upon recommendation by the Operator and concurrence by PCAC.
 - 6.2.7. The Operator will manage the proper upkeep of the buildings and grounds including life-cycle renovations and capital improvement projects.
 - 6.2.8. The Operator will prepare, deliver and collect on bills for rent and other fees due from the residents.
 - 6.2.9. The Operator will enforce terms of resident contracts including taking appropriate legal action, when necessary.

- 6.2.10. The Operator will create and maintain operating budgets for the SLC. Budgets will be presented yearly to the Board for approval. The Operator will maintain accurate and complete financial records of the SLC. These records will be made available to the Board on a periodic basis and, if requested, upon demand.
- 6.2.11. As appropriate and agreed, the Operator shall provide, periodically and at year-end, financial reports for internal control purposes and for use by PCAC in the preparation of external reporting and tax filing (e.g., quarterly financial statements filed in connection with debt issues, tax reports and other required information). Such information shall be supplied timely, accurately and completely.
- 6.2.12. The Operator will manage the SLC in a manner consistent with the mission and vision described in this RFP, and/or as otherwise may be communicated by PCAC or the College from time to time.

THE FOLLOWING SECTIONS 6.3 AND 6.4 ARE INCLUDED HEREIN FOR INFORMATIONAL PURPOSES ONLY

- 6.3. **Development Consultant.** (The information in this Section 6.3 is included in this RFP for informational purposes only.) PCAC intends to retain a Development Consultant who has a proven record of success in assisting similar not-for-profit organizations in all aspects of the development of senior housing projects. The Development Consultant will be responsible for the overall management of the design, approvals, initial marketing, construction and project turnover. Additionally, the Development Consultant will be required to closely coordinate with the Operator and the Investment Banker.
 - 6.3.1. The Development Consultant will be responsible for the sourcing and management of contracts with other professionals such as the project architects, interior design consultants, engineers, planners, landscape architects and marketing consultants. PCAC will contract directly for any other professionals necessary to properly develop the project. The Development Consultant will be required to assist PCAC in the selection and contract negotiations of these professionals and to coordinate and manage their work efforts.
 - 6.3.2. The Development Consultant, together with the other project professionals, will be responsible for managing all applications necessary for project approvals except for those approvals, licenses and certificates of need or authority necessary to operate the SLC. The latter shall be the responsibility of the Operator.
 - 6.3.3. The Development Consultant will be required to conduct thorough market research to determine, with input from the Operator and PCAC, the best unit types, designs and service offerings for the project and to determine the optimal initial pricing of products and services. The Development Consultant will be responsible for the sales and marketing of the project from initial project announcement, through pre-construction and until stabilization of the first phase of the project.
 - 6.3.4. The Development Consultant, with input from the Operator, will create and refine the project's architectural program for approval by PCAC.
 - 6.3.5. The Development Consultant will be responsible to manage the design team in the preparation of drawings and specifications suitable for construction of the buildings and site work, and for the procurement of furniture, fixtures and equipment of the facility.
 - 6.3.6. The project will be constructed by a reputable general contractor or construction management firm, contracted directly with PCAC. The Development Consultant will be responsible to assist PCAC in the selection and contract negotiations for the construction of the project. The Development Consultant will act in the capacity of the "Owner's Representative" during the construction period of the project and will be responsible for the orderly and successful turnover of the completed project.
 - 6.3.7. The Development Consultant will be expected to create and refine, from time to time, a detailed project pro forma and project budgets.
 - 6.3.8. As appropriate and agreed, the Development Consultant shall provide, periodically and at year-end, financial reports for internal control purposes and for use by PCAC in the preparation of external reporting and tax filing (e.g., quarterly financial statements filed in connection with debt issues, tax reports and other required information). Such information shall be supplied timely, accurately and completely.
 - 6.3.9. The Development Consultant will be expected to meet frequently with the team members and with the Board to provide progress updates, to make recommendations, to discuss critical elements of the project, and to receive direction.

- 6.4. **Investment Banker.** (The information in this Section 6.4 is included in this RFP for informational purposes only.) PCAC intends to enter into contractual agreements with a qualified firm to provide investment banking services for the procurement of seed money for development, short-term start-up financing, and permanent tax exempt bond financing for the project.
- 6.4.1. The Investment Banker shall have demonstrated experience and success in managing, underwriting, marketing and distributing tax exempt bonds and Bond Anticipation Notes for senior living facilities. The Investment Banker shall have a wide knowledge and significant experience working with industry leading senior living developers and operators. Additionally, the Investment Banker shall have demonstrated experience and success in arranging for initial, at-risk seed money for similar projects.
- 6.4.2. The Investment Banker shall create and maintain a comprehensive written financial strategy document for this project and for the PCAC including descriptions of types and amounts of debt, raises and other pertinent information related to the short and long term financing of the project. The Investment Banker shall coordinate this work effort with the Development Consultant and the Operator.
- 6.4.3. The Investment Banker shall actively seek investors to provide seed money for the initial development activities of the SLC. This initial funding shall be unsecured, with a return to the investor commensurate with the risk. The Investment Banker shall solicit competitive offers for the initial funding and advise PCAC of the advantages and disadvantages of each potential funding source.
- 6.4.4. PCAC anticipates that the source of the second tranche of funding will be from Bond Anticipation Notes (“BANs”). This second phase of funding will be required for the completion of the design of the project, for the pre-marketing of the project and for the preparation of documents and exhibits related to the procurement of permanent tax exempt bond financing. The Investment Banker will manage the issuance of the BANs through a local development authority such as the Westchester County Local Development Corporation, or through another authorized entity. The Investment Banker shall provide the underwriting, marketing and management of the issuance of the BANs.
- 6.4.5. Permanent financing for the project is anticipated to be through the sale of tax exempt bonds with a maturity of up to thirty (30) years. The permanent financing shall provide for the construction and development hard and soft costs, furniture, fixtures and equipment (FF&E), marketing, start-up losses, reserves, repayment of seed money and BANs, and interest carry cost until project stabilization for the first phase of the facility (approximately 200 units). PCAC expects that a reasonable loan to value ratio (“LTV”) for the project will be required. The LTV will be achieved by pledging the leasehold interest in the land and by demonstrating the project value through independent appraisals. The Investment Banker will manage the issuance of the tax exempt bonds through a local development authority such as the Westchester County Local Development Corporation, or through another authorized entity. The Investment Banker shall provide the underwriting, marketing and management of the issuance of the bonds.
- 6.4.6. PCAC understands and expects that a Liquidity Support Fund will be required as an enticement and condition of the sale of the bonds. PCAC anticipates that the total amount of funds to be made available in this fund, for use if the project does not perform as forecasted, could be in the range of \$5,000,000. PCAC anticipates that these funds will be made available through existing funds and/or a targeted capital giving campaign specific for this project.
- 6.4.7. As appropriate and agreed, the Investment Banker shall provide, periodically and at year-end, financial reports for internal control purposes and for use by PCAC in the preparation of external reporting and tax filing (e.g., quarterly financial statements filed in connection with debt issues, tax reports and other required information). Such information shall be supplied timely, accurately and completely.
- 6.5. **Contract Agreements.** PCAC, upon initial selection of the successful Development Consultant, Operator and Investment Banker (or combination thereof), will issue letters of intent to the firms intended to be awarded the contracts. PCAC and the firms will then negotiate, in good faith, mutually agreeable contract terms. If delays occur in the progress toward the execution of satisfactory contract agreements, PCAC reserves the right to initiate and/or continue discussions and negotiations with other respondents.

End of Section 6

7. Submission Requirements

7.1. **Requirements for All Submissions.** The following requirements apply to all submissions:

- 7.1.1. **Executive Summary.** Provide an Executive Summary of the proposal.
- 7.1.2. **Overview of the Proposed Project Team.** Provide an overview of the proposed project team. Include a detailed description of the organization of the proposed team, including identification and curriculum vitae for the key members of the team.
- 7.1.3. **Vision Statement.** Provide a Project Vision Statement. Be explicit in describing the methods proposed for the achievement of the vision and mission of the project and for the integration of the SLC with the culture of Purchase College. Describe any characteristics that make the respondent uniquely qualified to provide the services proposed.
- 7.1.4. **Experience.** Respondent's qualifications should demonstrate expertise, financial capacity and proven experience in senior living and multi-family residential development and management, mixed income/affordable housing development and management, public-private partnerships and/or tax exempt bond financing, as applicable to the scope of the response. Respondents should provide informative details of up to five (5) comparable projects within the last fifteen years. Respondents should list all experience in New York State within the previous five (5) years. Examples of prior experience, as may be applicable to the scope of the services proposed, should include:
- 7.1.4.1. Name, address and location of project;
 - 7.1.4.2. Project descriptions including land area, building square footage (broken down by use), residential unit mix, parking, and construction type;
 - 7.1.4.3. Development team members including lead developer, project architect, general contractor, lender(s) and equity provider(s);
 - 7.1.4.4. References including names, addresses, telephone numbers and email addresses and a letter authorizing each reference to respond to inquiries;
 - 7.1.4.5. Site plans and photographs;
 - 7.1.4.6. Development costs including total project development costs, hard costs by product type, soft costs, financing costs, and development fees;
 - 7.1.4.7. Sources and amounts of project funding;
 - 7.1.4.8. Project timeline with milestones achieved from initial planning through construction completion to lease up, as well as current status;
 - 7.1.4.9. Challenges associated with the project;
 - 7.1.4.10. Any factual measures of success including initial budget versus final cost, projected stabilized net operating income (NOI) versus actual NOI, and satisfaction of concerns of public entities and of the general public.
- 7.1.5. **Vendor Responsibility.** Complete and file the Vendor Responsibility Questionnaire, included as Attachment 1, in accordance with the requirements in Part I, paragraph O. of this RFP.
- 7.1.6. **Conflicts of Interest.** Provide details of any potential conflicts of interest including existing business or personal relationships with any member of the Purchase College team or of the Board.
- 7.1.7. **Financial Capacity and Qualifications.** Provide detailed information regarding the financial capacity to complete the services proposed. Information may include certified financial statements of the company and/or correspondence from reputable financial institutions indicating financial capacity. Provide the names and addresses of at least three (3) commercial or institutional credit references and a letter authorizing each credit reference to respond to inquiries.
- 7.1.8. **MBE-WBE-MWBE Status.** Each responding firm shall provide its status relative to MBE, WBE, and/or MWBE, where:
- MBE = New York State certified Minority Business Enterprise;
 - WBE = New York State certified Woman Business Enterprise; and
 - MWBE = New York State certified Minority+Woman Business Enterprise.
- 7.1.9. Complete and submit Attachment 1, the Submission Form – Bid Proposer Info.

- 7.2. **Submission Requirements Specific to the Operator.** In addition to the submission requirements of Section 7.1, respondents to the Operator RFP shall submit information required by this Section 7.3. Describe the respondent's approach to the operations of the SLC including:
- 7.2.1. Describe the specific methods the respondent proposes to address the stated mission and vision of the project;
 - 7.2.2. Submit a preliminary operations, maintenance, and property management plan describing the strategies and costs associated with community operations, maintenance, and management. The plan should describe operations including resident services such as, but not limited to, meals, housekeeping, health care, and amenity provisions. Provide a narrative regarding the approach to budgeting for annual operations, utilities, furnishings, maintenance and repair, capital replacement, and services provided by the College;
 - 7.2.3. Provide a copy of the respondent's professional and medical malpractice insurance coverage, which should include abuse and molestation coverage;
 - 7.2.4. Provide a summary of any litigation your firm has been involved within the past three years including the status of each case. Provide a list and description of any outstanding state or local health department violations for any properties under management;
 - 7.2.5. Provide a detailed proposal for financial compensation for the proposed services. The proposal shall indicate the total yearly fee amount, expressed as a base yearly fee plus a percentage of the total yearly community operating costs, excluding project financing costs. The proposal shall also indicate the estimated amount and timing of any reimbursable expenses.

For the purpose of evaluating the proposals, each proposal submitted shall use the following assumptions:

Total project hard and soft costs:	\$150,000,000
Total yearly operating costs (200 units in 2013 dollars):	\$8,000,000

Project Milestones:	Execution of Contracts.....	3/1/2014
	Project Approvals.....	3/1/2015
	Completion of Design.....	3/1/2016
	Start of Construction.....	3/1/2017
	Completion of First Phase.....	3/1/2018
	Stabilized Occupancy.....	3/1/2019
	End of Initial Management Contract.....	3/1/2024

THE FOLLOWING SECTIONS 7.3 AND 7.4 ARE INCLUDED HEREIN FOR INFORMATIONAL PURPOSES ONLY. RESPONDENTS ARE NOT TO COMPLETE THESE SECTIONS AS A PART OF THE RESPONSE TO THIS OPERATIONS MANAGEMENT RFP.

- 7.3. **Submission Requirements Specific to the Development Consultant.** (The information in this Section 7.3 is included in this RFP for informational purposes only.) In addition to the submission requirements of Section 7.1, the Development Consultant shall submit information required by this Section 7.2. Describe the respondent's approach to the development of the project including:
- 7.3.1. A narrative of the vision of the project;
 - 7.3.2. Specific methods the respondent proposes to addresses the stated goals of the project;
 - 7.3.3. Brief market overview supporting the development program;
 - 7.3.4. Brief description of the anticipated development program including unit mix, unit sizes, common facilities, infrastructure improvements, recreational facilities and treatment of the C&D landfill site;
 - 7.3.5. Anticipated phasing plan;
 - 7.3.6. Anticipated impact on public facilities, surrounding properties and on Purchase College;

- 7.3.7. Preliminary estimation of costs for each element of the development;
- 7.3.8. Respondents may consider submitting rendered site plans, rendered building plans, photographs of similar projects, or any other material that may inform the intent of the development and/or the capabilities of the respondent;
- 7.3.9. Provide an anticipated project schedule including the durations and key milestones for entitlements, design, issuance of building permits, construction, fill-up and stabilized occupancy;
- 7.3.10. Provide a description of the approach for community and stakeholder outreach and for public relations related to the project;
- 7.3.11. Provide a detailed proposal for financial consideration for the proposed services. The proposal shall indicate the total fee amount, expressed as a percentage of the total project hard and soft costs, excluding project financing costs. The proposal shall also indicate the timing and/or project milestones at which time portions of the fee will be earned. The proposal shall also indicate the estimated amount and timing of any reimbursable expenses.

For the purpose of evaluating the proposals, each proposal submitted shall use the following assumptions:

Total project hard and soft costs: \$150,000,000

Project Milestones:	Execution of Contracts.....	3/1/2014
	Project Approvals.....	3/1/2015
	Completion of Design.....	3/1/2016
	Start of Construction.....	3/1/2017
	Completion of First Phase.....	3/1/2018
	Stabilized Occupancy.....	3/1/2019

7.4. Submission Requirements Specific to the Investment Banker. (The information in this Section 7.4 is included in this RFP for informational purposes only.) In addition to the submission requirements of Section 7.1, the following information is required specific to the Investment Banker RFP:

- 7.4.1. Provide a detailed description of the approach for securing at-risk initial financing (seed money) for the project. Indicate anticipated costs and conditions associated with the financing.
- 7.4.2. Provide a detailed description of the methods and strategies for the underwriting and marketing of both the BANs and the tax exempt bond issuance.
- 7.4.3. Provide a detailed proposal for financial compensation for the proposed services. The proposal shall indicate the total fee and/or commission to be earned and paid, expressed as a percentage of the total amount financed for each element of the services. The proposal shall also indicate the estimated amount and timing of any reimbursable expenses.

For the purpose of evaluating the proposals, each proposal submitted shall use the following assumptions:

Total project hard and soft costs: \$150,000,000

Project Milestones:	Execution of Contracts.....	3/1/2014
	Initial At-Risk Funding.....	6/1/2014
	Project Approvals.....	3/1/2015
	Bond Anticipation Note Financing.....	3/1/2015
	Completion of Design.....	3/1/2016
	Permanent Bond Financing.....	1/1/2017
	Start of Construction.....	3/1/2017
	Completion of First Phase.....	3/1/2018
	Stabilized Occupancy.....	3/1/2019

End of Section 7

8. Proposal Evaluation Criteria

- 8.1. As previously stated, PCAC is seeking a Development Consultant, an Operator and an Investment Banker who, collectively, can provide for the successful implementation of a senior learning community on the Purchase College campus.
- 8.2. Evaluation criteria will be separated into several components for each of the respondents. Each component will be weighted for the purpose of scoring the proposals.

8.2.1. Proposals Specific to the Operator.

- 8.2.1.1. **Experience.** The experience of the proposed team in managing similar projects will be evaluated. Included in the evaluation of this element will be an assessment of the number and quality of successfully managed projects of similar scope and size. The experience and success of the key personnel of the team will also be evaluated, as will the capacity of the firm to manage the project, given its current and anticipated workloads. This element will be **weighted at 25%**.
- 8.2.1.2. **Presentations and Interviews.** The Selection Advisory Committee, defined in Section 9.1, will invite all respondents who have submitted complete proposals to present their proposals to the Committee and to participate in a formal interview process. The Committee will evaluate the respondents' demonstration of knowledge of the industry and requirements for successful operations management and of their understanding of the project's scope and mission. This component will be **weighted at 20%**.
- 8.2.1.3. **Financial Consideration.** The proposals will be evaluated based on total fee amounts and on the timing that fees will be earned. This component will be **weighted at 30%**.
- 8.2.1.4. **Project Vision and Operations Plan.** Respondents will be evaluated on their Project Vision Statement and on their approach to the operations and management of the SLC. Specific focus will be given to the respondent's approach for successful integration of the SLC with the college. This component will be **weighted at 20%**.
- 8.2.1.5. **MBE-WBE-MWBE Status.** Certified status as a New York State MBE, WBE or MWBE will be **weighted at 5%**.

THE FOLLOWING SECTIONS 8.2.2 AND 8.2.3 ARE INCLUDED HEREIN FOR INFORMATIONAL PURPOSES ONLY

8.2.2. **Proposals Specific to the Development Consultant.** (The information in this Section 8.2.2 is included in this RFP for informational purposes only.)

- 8.2.2.1. **Experience.** The experience of the proposed team in executing similar projects will be evaluated. Included in the evaluation of this element will be an assessment of the number and quality of successfully completed projects of similar scope and size. The experience and success of the key personnel of the team will also be evaluated, as will the capacity of the firm to execute the project, given its current and anticipated workloads. This component will be **weighted at 25%**.
- 8.2.2.2. **Presentations and Interviews.** The Selection Advisory Committee, defined in Section 9.1, will invite all respondents who have submitted complete proposals to present their proposals to the Committee and to participate in a formal interview process. The Committee will evaluate the respondents' demonstration of knowledge of the industry and of the development processes and of their understanding of the project's scope and mission. This component will be **weighted at 20%**.
- 8.2.2.3. **Financial Consideration.** The proposals will be evaluated based on total fee amounts and on the timing and/or milestones at which times fees will be earned. This component will be **weighted at 30%**.
- 8.2.2.4. **Project Vision and Conceptual Planning.** Respondents will be evaluated on their Project Vision Statement and on their approach to the land planning, architectural programming, marketing, and operational programming for the project. This component will be **weighted at 20%**.
- 8.2.2.5. **MBE-WBE-MWBE Status.** Certified status as a New York State MBE, WBE or MWBE will be **weighted at 5%**.

8.2.3. **Proposals Specific to the Investment Banker.** (The information in this Section 8.2.3 is included in this RFP for informational purposes only.)

8.2.3.1. **Experience.** The experience of the proposed team in financing similar projects will be evaluated. Included in the evaluation of this element will be an assessment of the number and quality of successfully financed projects of similar scope and size. The experience and success of the key personnel of the team will also be evaluated, as will the capacity of the firm to manage the project, given its current and anticipated workloads. This component will be **weighted at 25%**.

8.2.3.2. **Presentations and Interviews.** The Selection Advisory Committee, defined in Section 9.1, will invite all respondents who have submitted complete proposals to present their proposals to the Committee and to participate in a formal interview process. The Committee will evaluate the respondents' demonstration of knowledge of the industry and of the financing processes and of their understanding of the project's scope and mission. This component will be **weighted at 20%**.

8.2.3.3. **Financial Consideration.** The proposals will be evaluated based on the total amount and timing of fee and/or commission to be earned for each financing element. This component will be **weighted at 30%**.

8.2.3.4. **Project Vision and Financing Plan.** Respondents will be evaluated on their Project Vision Statement and on their approach to the financing for the project. This component will be **weighted at 20%**.

8.2.3.5. **MBE-WBE-MWBE Status.** Certified status as a New York State MBE, WBE or MWBE will be **weighted at 5%**.

End of Section 8

9. Proposal Evaluation and Selection Process

- 9.1. Prior to the deadline for proposal submissions, PCAC will form a Selection Advisory Committee (the “Committee”) consisting of three to seven members knowledgeable of the goals of the project. These committee members may include members of the Board and/or persons with special expertise in the field of senior housing and services and/or special knowledge of the operations and goals of the College.
- 9.2. The Committee will study and evaluate each properly submitted proposal. The Committee may ask for additional information from respondents and will conduct interviews with all of the respondents who have submitted complete proposals. The proposals will be evaluated and scored in accordance with the criteria set forth in Section 8 of this RFP.
- 9.3. Upon completion of the study and evaluation of the proposals, the Committee will make formal recommendations to the PCAC Board of Directors. The Board may accept and act on the recommendations, or may choose to take no action at all.
- 9.4. Upon selection by the Board of the successful respondents, PCAC, through its officers, will negotiate in good faith with the successful respondents the terms of agreements. In the event terms of agreements cannot be agreed upon, PCAC reserves the right to negotiate with other respondents.
- 9.5. All respondents submitting properly completed proposals will be notified in writing of the Board’s decisions.

End of Section 9

The parties to the attached contract, license, lease, amendment or other agreement of any kind (hereinafter, "contract") agree to be bound by the following clauses which are hereby made a part of the contract (the word "Contractor" herein refers to any party other than the State, whether a Contractor, licensor, licensee, lessor, lessee or any other party):

1. **EXECUTORY CLAUSE.** In accordance with Section 41 of the State Finance Law, the State shall have no liability under this contract to the Contractor or to anyone else beyond funds appropriated and available for this contract.

2. **PROHIBITION AGAINST ASSIGNMENT** Except for the assignment of its right to receive payments subject to Article 5-A of the State Finance Law, the Contractor selected to perform the services herein are prohibited in accordance with Section 138 of the State Finance Law from assigning, transferring, conveying, subletting or otherwise disposing of its rights, title or interest in the contract without the prior written consent of SUNY and attempts to do so are null and void. Notwithstanding the foregoing, SUNY may, with the concurrence of the New York Office of State Comptroller, waive prior written consent of the assignment, transfer, conveyance, sublease or other disposition of a contract let pursuant to Article XI of the State Finance Law if the assignment, transfer, conveyance, sublease or other disposition is due to a reorganization, merger or consolidation of Contractor's its business entity or enterprise and Contractor so certifies to SUNY. SUNY retains the right, as provided in Section 138 of the State Finance Law, to accept or reject an assignment, transfer, conveyance, sublease or other disposition of the contract, and to require that any Contractor demonstrate its responsibility to do business with SUNY.

3. **COMPTROLLER'S APPROVAL.** (a) In accordance with Section 112 of the State Finance Law, Section 355 of New York State Education Law, and 8 NYCRR 316, Comptroller's approval is not required for the following contracts: (i) materials; (ii) equipment and supplies, including computer equipment; (iii) motor vehicles; (iv) construction; (v) construction-related services; (vi) printing; and (vii) goods for State University health care facilities, including contracts for goods made with joint or group purchasing arrangements.

(b) Comptroller's approval is required for the following contracts: (i) contracts for services not listed in Paragraph (3)(a) above made by a State University campus or health care facility certified by the Vice Chancellor and Chief Financial Officer, if the contract value exceeds \$250,000; (ii) contracts for services not listed in Paragraph (3)(a) above made by a State University campus not certified by the Vice Chancellor and Chief Financial Officer, if the contract value exceeds \$50,000; (iii) contracts for services not listed in Paragraph (3)(a) above made by health care facilities not certified by the Vice Chancellor and Chief Financial Officer, if the contract value exceeds \$75,000; (iv) contracts whereby the State University agrees to give something other than money, when the value or reasonably estimated value of such consideration exceeds \$10,000; (v) contracts for real property transactions if the contract value exceeds \$50,000; (vi) all other contracts not listed in Paragraph 3(a) above, if the contract value exceeds \$50,000, e.g. SUNY acquisition of a business and New York State Finance Article 11-B contracts and (vii) amendments for any amount to contracts not listed in Paragraph (3)(a) above, when as so amended, the contract exceeds the threshold amounts stated in Paragraph (b) herein. However, such pre-approval shall not be required for any contract established as a centralized contract through the Office of General Services or for a purchase order or other transaction issued under such centralized contract.

(c) Any contract that requires Comptroller approval shall not be valid, effective or binding upon the State University until it has been approved by the Comptroller and filed in the Comptroller's office.

4. **WORKERS' COMPENSATION BENEFITS.** In accordance with Section 142 of the State Finance Law, this contract shall be void and of no force and effect unless the Contractor shall provide and maintain coverage during the life of this contract for the benefit of such employees as are required to be covered by the provisions of the Workers' Compensation Law.

5. **NON-DISCRIMINATION REQUIREMENTS.** To the extent required by Article 15 of the Executive Law (also known as the Human Rights Law) and all other State and Federal statutory and constitutional non-discrimination provisions, the Contractor will not discriminate against any employee or applicant for employment because of race, creed, color, sex, national origin, sexual orientation, age, disability, genetic predisposition or carrier status, or marital status. Furthermore, in accordance with Section 220-e of the Labor Law, if this is a contract for the construction, alteration or repair of any public building or public work or for the manufacture, sale or distribution of materials, equipment or supplies, and to the extent that this contract shall be performed within the State of New York, Contractor agrees that neither it nor its subcontractors shall, by reason of race, creed, color, disability, sex, or national origin: (a) discriminate in hiring against any New York State citizen who is qualified and available to perform the work; or (b) discriminate against or intimidate any employee hired for the performance of work under this contract. If this is a building service contract as defined in Section 230 of the Labor Law, then, in accordance with Section 239 thereof, Contractor agrees that neither it nor its subcontractors shall by reason of race, creed, color, national origin, age, sex or disability: (a) discriminate in hiring against any New York State citizen who is qualified and available to perform the work; or (b) discriminate against or intimidate any employee hired for the performance of work under this contract. Contractor is subject to fines of \$50.00 per person per day for any violation of Section 220-e or Section 239 as well as possible termination of this contract and forfeiture of all moneys due hereunder for a second or subsequent violation.

6. **WAGE AND HOURS PROVISIONS.** If this is a public work contract covered by Article 8 of the Labor Law or a building service contract covered by Article 9 thereof, neither Contractor's employees nor the employees of its subcontractors may be required or permitted to work more than the number of hours or days stated in said statutes, except as otherwise provided in the Labor Law and as set forth in prevailing wage and supplement schedules issued by the State Labor Department. Furthermore, Contractor and its subcontractors must pay at least the prevailing wage rate and pay or provide the prevailing supplements, including the premium rates for overtime pay, as determined by the State Labor Department in accordance with the Labor Law. Additionally, effective April 28, 2008, if this is a public work contract covered by Article 8 of the Labor Law, the Contractor understands and agrees that the filing of payrolls in a manner consistent with Subdivision 3-a of Section 220 of the Labor Law shall be a condition precedent to payment by SUNY of any SUNY-approved sums due and owing for work done upon the project.

7. **NON-COLLUSIVE BIDDING CERTIFICATION.** In accordance with Section 139-d of the State Finance Law, if this contract was awarded based on the submission of competitive bids, Contractor affirms, under penalty of perjury, and each person signing on behalf of Contractor, and in the case of a joint bid each party thereto certifies as to its own organization, under penalty of perjury, that to the best of its knowledge and belief that its bid was arrived at independently and without collusion aimed at restricting competition. Contractor further affirms that, at the time Contractor submitted its bid, an authorized and responsible person executed and delivered it to SUNY a non-collusive bidding certification on Contractor's behalf.

8. **INTERNATIONAL BOYCOTT PROHIBITION.** In accordance with Section 220-f of the Labor Law and Section 139-h of the State Finance Law, if this contract exceeds \$5,000, the Contractor agrees, as a material condition of the contract, that neither the Contractor nor any substantially owned or affiliated person, firm, partnership or corporation has participated, is participating, or shall participate in an international boycott in violation of the federal Export Administration Act of 1979 (50 USC App. Sections 2401 *et seq.*) or regulations thereunder. If such Contractor, or any of the aforesaid affiliates of Contractor, is convicted or is otherwise found to have violated said laws or regulations upon the final determination of the United States Commerce Department or any other appropriate agency of the United States subsequent to the contract's execution, such contract, amendment or modification thereto shall be rendered forfeit and void. The Contractor shall so notify the State Comptroller within five (5) business days of such conviction, determination or disposition of appeal (2 NYCRR 105.4).

9. **SET-OFF RIGHTS.** The State shall have all of its common law, equitable and statutory rights of set-off. These rights shall include, but not be limited to, the State's option to withhold for the purposes of set-off any moneys due to the Contractor under this contract up to any amounts due and owing to the State with regard to this contract, any other contract with any State department or agency, including any contract for a term commencing prior to the term of this contract, plus any amounts due and owing to the State for any other reason including, without limitation, tax delinquencies or monetary penalties relative thereto. The State shall exercise its set-off rights in accordance with normal State practices including, in cases of set-off pursuant to an audit, the finalization of such audit by the State, its representatives, or the State Comptroller.

10. **RECORDS.** The Contractor shall establish and maintain complete and accurate books, records, documents, accounts and other evidence directly pertinent to performance under this contract (hereinafter, collectively, "the Records"). The Records must be kept for the balance of the calendar year in which they were made and for six (6) additional years thereafter. The State Comptroller, the Attorney General and any other person or entity authorized to conduct an examination, as SUNY and its representatives and entities involved in this contract, shall have access to the Records during normal business hours at an office of the Contractor within the State of New York or, if no such office is available, at a mutually agreeable and reasonable venue within the State, for the term specified above for the purposes of inspection, auditing and copying.

SUNY shall take reasonable steps to protect from public disclosure any of the Records which are exempt from disclosure under Section 87 of the Public Officers Law (the "Statute") provided that: (i) the Contractor shall timely inform an appropriate SUNY official, in writing, that said Records should not be disclosed; and (ii) said Records shall be sufficiently identified; and (iii) designation of said Records as exempt under the Statute is reasonable. Nothing contained herein shall diminish, or in any way adversely affect, SUNY's or the State's right to discovery in any pending or future litigation.

11. IDENTIFYING INFORMATION AND PRIVACY NOTIFICATION.

Identification Number(s). Every invoice or New York State Claim for Payment submitted to the State University of New York by a payee, for payment for the sale of goods or services or for transactions (e.g., leases, easements, licenses, etc.) related to real or personal property must include the payee's identification number. The number is any or all of the following: (i) the payee's Federal employer identification number, (ii) the payee's Federal social security number, and/or (iii) the payee's Vendor Identification Number assigned by the Statewide Financial System. Failure to include such number or numbers may delay payment. Where the payee does not have such number or numbers, the payee, on its invoice or Claim for Payment, must give the reason or reasons why the payee does not have such number or numbers.

(b) Privacy Notification. (1) The authority to request the above personal information from a seller of goods or services or a lessor of real or personal property, and the authority to maintain such information, is found in Section 5 of the State Tax Law. Disclosure of this information by the seller or lessor to the State University of New York is mandatory. The principal purpose for which the information is collected is to enable the State to identify individuals, businesses and others who have been delinquent in filing tax returns or may have understated their tax liabilities and to generally identify persons affected by the taxes administered by the Commissioner of Taxation and Finance. The information will be used for tax administration purposes and for any other purpose authorized by law. (2) The personal information is requested by the purchasing unit of the State University of New York contracting to purchase the goods or services or lease the real or personal property covered by this contract or lease. The information is maintained in the Statewide Financial System by the Vendor Management Unit within the Bureau of State Expenditures, Office of the State Comptroller, 110 State Street, Albany, New York 12236.

12. EQUAL EMPLOYMENT OPPORTUNITIES FOR MINORITIES AND WOMEN.

(a) In accordance with Section 312 of the Executive Law and 5 NYCRR 143, if this contract is: (i) a written agreement or purchase order instrument, providing for a total expenditure in excess of \$25,000.00, whereby a contracting agency is committed to expend or does expend funds in return for labor, services, supplies, equipment, materials or any combination of the foregoing, to be performed for, or rendered or furnished to the contracting agency; or (ii) a written agreement in excess of \$100,000.00 whereby a contracting agency is committed to expend or does expend funds for the acquisition, construction, demolition, replacement, major repair or renovation of real property and improvements thereon; or (iii) a written agreement in excess of \$100,000.00 whereby the owner of a State assisted housing project is committed to expend or does expend funds for the acquisition, construction, demolition, replacement, major repair or renovation of real property and improvements thereon for such project, then the following shall apply and by signing this agreement the Contractor certifies and affirms that it is Contractor's equal employment opportunity policy that:

(1) The Contractor will not discriminate against employees or applicants for employment because of race, creed, color, national origin, sex, age, disability or marital status, and will undertake or continue existing programs of affirmative action to ensure that minority group members and women are afforded equal employment opportunities without discrimination. Affirmative action shall mean recruitment, employment, job assignment, promotion, upgradings, demotion, transfer, layoff, or termination and rates of pay or other forms of compensation;

(2) at SUNY's request, Contractor shall request each employment agency, labor union, or authorized representative of workers with which it has a collective bargaining or other agreement or understanding, to furnish a written statement that such employment agency, labor union or representative will not discriminate on the basis of race, creed, color, national origin, sex, age, disability or marital status and that such union or representative will affirmatively cooperate in the implementation of the Contractor's obligations herein; and

(3) Contractor shall state, in all solicitations or advertisements for employees, that, in the performance of the State contract, all qualified applicants will be afforded equal employment opportunities without discrimination because of race, creed, color, national origin, sex, age, disability or marital status.

(b) Contractor will include the provisions of "1", "2" and "3", above, in every subcontract over \$25,000.00 for the construction, demolition, replacement, major repair, renovation, planning or design of real property and improvements thereon (the "Work") except where the Work is for the beneficial use of the Contractor. Section 312 does not apply to: (i) work, goods or services unrelated to this contract; or (ii) employment outside New York State. The State shall consider compliance by a Contractor or sub-contractor with the requirements of any federal law concerning equal employment opportunity which effectuates the purpose of this section. SUNY shall determine whether the imposition of the requirements of the provisions hereof duplicate or conflict with any such federal law and if such duplication or conflict exists, SUNY shall waive the applicability of Section 312 to the extent of such duplication or conflict. Contractor will comply with all duly promulgated and lawful rules and regulations of the Department of Economic Development's Division of Minority and Women's Business Development pertaining hereto.

13. **CONFLICTING TERMS.** In the event of a conflict between the terms of the contract (including any and all attachments thereto and amendments thereof) and the terms of this Exhibit A, the terms of this Exhibit A shall control.

14. **GOVERNING LAW.** This contract shall be governed by the laws of the State of New York except where the Federal supremacy clause requires otherwise.

15. **LATE PAYMENT.** Timeliness of payment and any interest to be paid to Contractor for late payment shall be governed by Article 11-A of the State Finance Law to the extent required by law.

16. **NO ARBITRATION.** Disputes involving this contract, including the breach or alleged breach thereof, may not be submitted to binding arbitration (except where statutorily authorized) but must, instead, be heard in a court of competent jurisdiction of the State of New York.

17. **SERVICE OF PROCESS.** In addition to the methods of service allowed by the State Civil Practice Law & Rules ("CPLR"), Contractor hereby consents to service of process upon it by registered or certified mail, return receipt requested. Service hereunder shall be complete upon Contractor's actual receipt of process or upon the State's receipt of the return thereof by the United States Postal Service as refused or undeliverable. Contractor must promptly notify the State, in writing, of each and every change of address to which service of process can be made. Service by the State to the last known address shall be sufficient. Contractor will have thirty (30)

calendar days after service hereunder is complete in which to respond.

18. **PROHIBITION ON PURCHASE OF TROPICAL HARDWOODS.** The Contractor certifies and warrants that all wood products to be used under this contract award will be in accordance with, but not limited to, the specifications and provisions of State Finance Law §165 (Use of Tropical Hardwoods), which prohibits purchase and use of tropical hardwoods, unless specifically exempted, by the State or any governmental agency or political subdivision or public benefit corporation. Qualification for an exemption under this law will be the responsibility of the contractor to establish to meet with the approval of the State. In addition, when any portion of this contract involving the use of woods, whether supply or installation, is to be performed by any subcontractor, the prime Contractor will indicate and certify in the submitted bid proposal that the subcontractor has been informed and is in compliance with specifications and provisions regarding use of tropical hardwoods as detailed in Section 165 of the State Finance Law. Any such use must meet with the approval of the State, otherwise, the bid may not be considered responsive. Under bidder certification, proof of qualification for exemption will be the responsibility of the Contractor to meet with the approval of the State.

19. **MacBRIDE FAIR EMPLOYMENT PRINCIPLES.** In accordance with the MacBride Fair Employment Principles (Chapter 807 of the Laws of 1992), the Contractor hereby stipulates that Contractor and any individual or legal entity in which the Contractor holds a ten percent or greater ownership interest and any individual or legal entity that holds a ten percent or greater ownership interest in the Contractor either (a) have no business operations in Northern Ireland, or (b) shall take lawful steps in good faith to conduct any business operations in Northern Ireland in accordance with the MacBride Fair Employment Principles (as described in Section 165(5) of the State Finance Law), and shall permit independent monitoring of compliance with such principles.

20. **OMNIBUS PROCUREMENT ACT OF 1992.** It is the policy of New York State to maximize opportunities for the participation of New York State business enterprises, including minority and women-owned business enterprises as bidders, subcontractors and suppliers on its procurement contracts.

Information on the availability of New York State subcontractors and suppliers is available from:

NYS Department of Economic Development
Division for Small Business
30 South Pearl St., 7th Floor
Albany, NY 12245
Tel: 518-292-5100
Fax: 518-292-5884
email: opa@esd.ny.gov
A directory of certified minority and women-owned business enterprises is available from:
NYS Department of Economic Development
Division of Minority and Women's Business Development
633 Third Avenue
New York, NY 10017
212-803-2414

email: mwb certification@esd.ny.gov
<http://esd.ny.gov/MWBE/directorySearch.html>

The Omnibus Procurement Act of 1992 requires that by signing this bid proposal or contract, as applicable, Contractors certify that whenever the total bid amount is greater than \$1 million:

(a) The Contractor has made reasonable efforts to encourage the participation of New York State Business Enterprises as suppliers and subcontractors, including certified minority and women-owned business enterprises, on this project, and has retained the documentation of these efforts to be provided upon request to SUNY;

(b) The Contractor has complied with the Federal Equal Employment Opportunity Act of 1972 (P.L. 92-261), as amended;

(c) The Contractor agrees to make reasonable efforts to provide notification to New York State residents of employment opportunities on this project through listing any such positions with the Job Search Division of the New York State Department of Labor, or providing such notification in such manner as is consistent with existing collective bargaining contracts or agreements. The contractor agrees to document these efforts and to provide said documentation to the State upon request; and

(d) The Contractor acknowledges notice that SUNY may seek to obtain offset credits from foreign countries as a result of this contract and agrees to cooperate with SUNY in these efforts.

21. RECIPROCIITY AND SANCTIONS

PROVISIONS. Bidders are hereby notified that if their principal place of business is located in a country, nation, province, state or political subdivision that penalizes New York State vendors, and if the goods or services they offer will be substantially produced or performed outside New York State, the Omnibus Procurement Act of 1994 and 2000 amendments (Chapter 684 and Chapter 383, respectively) require that they be denied contracts which they would otherwise obtain. Contact the NYS Department of Economic Development, Division for Small Business, 30 South Pearl Street, Albany, New York 12245, for a current list of jurisdictions subject to this provision.

22. COMPLIANCE WITH NEW YORK STATE INFORMATION SECURITY BREACH AND

NOTIFICATION ACT. Contractor shall comply with the provisions of the New York State Information Security Breach and Notification Act (General Business Law Section 899-aa; State Technology Law Section 208).

23. COMPLIANCE WITH CONSULTANT DISCLOSURE LAW If this is a contract for consulting services, defined for purposes of this requirement to include analysis, evaluation, research, training, data processing, computer programming, engineering, environmental health and mental health services, accounting, auditing, paralegal, legal or similar services, then in accordance with Section 163(4-g) of the State Finance Law, the Contractor shall timely, accurately and properly comply with the requirement to submit an annual employment report for the contract to SUNY, the Department of Civil Service and the State Comptroller.

24. PURCHASES OF APPAREL AND SPORTS EQUIPMENT. In accordance with State Finance Law Section 165(7), SUNY may determine that a bidder on a contract for the purchase of apparel or sports equipment is not a responsible bidder as defined in State Finance Law Section 163 based on (a) the labor standards applicable to the manufacture of the apparel or sports equipment, including employee compensation, working conditions, employee rights to form unions and the use of child labor; or (b) bidder's failure to provide information sufficient for SUNY to determine the labor conditions

applicable to the manufacture of the apparel or sports equipment.

25. PROCUREMENT LOBBYING. To the extent this agreement is a "procurement contract" as defined by State Finance Law Sections 139-j and 139-k, by signing this agreement the contractor certifies and affirms that all disclosures made in accordance with State Finance Law Sections 139-j and 139-k are complete, true and accurate. In the event such certification is found to be intentionally false or intentionally incomplete, the State may terminate the agreement by providing written notification to the Contractor in accordance with the terms of the agreement.

26. CERTIFICATION OF REGISTRATION TO COLLECT SALES AND COMPENSATING USE TAX BY CERTAIN STATE CONTRACTORS, AFFILIATES AND SUBCONTRACTORS. To the extent this agreement is a contract as defined by Tax Law Section 5-a, if the Contractor fails to make the certification required by Tax Law Section 5-a or if during the term of the contract, the Department of Taxation and Finance or SUNY discovers that the certification, made under penalty of perjury, is false, then such failure to file or false certification shall be a material breach of this contract and this contract may be terminated, by providing written notification to the Contractor in accordance with the terms of the agreement, if SUNY determines that such action is in the best interests of the State.

THE FOLLOWING PROVISIONS SHALL APPLY ONLY TO THOSE CONTRACTS TO WHICH A HOSPITAL OR OTHER HEALTH SERVICE FACILITY IS A PARTY

27. Notwithstanding any other provision in this contract, the hospital or other health service facility remains responsible for insuring that any service provided pursuant to this contract complies with all pertinent provisions of Federal, state and local statutes, rules and regulations. In the foregoing sentence, the word "service" shall be construed to refer to the health care service rendered by the hospital or other health service facility.

28. (a) In accordance with the 1980 Omnibus Reconciliation Act (Public Law 96-499), Contractor hereby agrees that until the expiration of four years after the furnishing of services under this agreement, Contractor shall make available upon written request to the Secretary of Health and Human Services, or upon request, to the Comptroller General of the United States or any of their duly authorized representatives, copies of this contract, books, documents and records of the Contractor that are necessary to certify the nature and extent of the costs hereunder.

(b) If Contractor carries out any of the duties of the contract hereunder, through a subcontract having a value or cost of \$10,000 or more over a twelve-month period, such subcontract shall contain a clause to the effect that, until the expiration of four years after the furnishing of such services pursuant to such subcontract, the subcontractor shall make available upon written request to the Secretary of Health and Human Services or upon request to the Comptroller General of the United States, or any of their duly authorized representatives, copies of the subcontract and books, documents and records of the subcontractor that are necessary to verify the nature and extent of the costs of such subcontract.

(c) The provisions of this section shall apply only to such contracts as are within the definition established by the Health Care Financing Administration, as may be amended or modified from time to time.

1. DEFINITIONS. The following terms shall be defined in accordance with Section 310 of the Executive Law:

STATE CONTRACT herein referred to as "State Contract", shall mean: (a) a written agreement or purchase order instrument, providing for a total expenditure in excess of twenty-five thousand dollars (\$25,000.00), whereby the State University of New York ("University") is committed to expend or does expend funds in return for labor, services including but not limited to legal, financial and other professional services, supplies, equipment, materials or a combination of the foregoing, to be performed for, or rendered or furnished to the University; (b) a written agreement in excess of one hundred thousand dollars (\$100,000.00) whereby the University is committed to expend or does expend funds for the acquisition, construction, demolition, replacement, major repair or renovation of real property and improvements thereon; and (c) a written agreement in excess of one hundred thousand dollars (\$100,000.00) whereby the University as an owner of a state assisted housing project is committed to expend or does expend funds for the acquisition, construction, demolition, replacement, major repair or renovation of real property and improvements thereon for such project.

SUBCONTRACT herein referred to as "Subcontract", shall mean any agreement for a total expenditure in excess of \$25,000 providing for services, including non-staffing expenditures, supplies or materials of any kind between a State agency and a prime contractor, in which a portion of the prime contractor's obligation under the State contract is undertaken or assumed by a business enterprise not controlled by the prime contractor.

WOMEN-OWNED BUSINESS ENTERPRISE herein referred to as "WBE", shall mean a business enterprise, including a sole proprietorship, partnership or corporation that is: (a) at least fifty-one percent (51%) owned by one or more United States citizens or permanent resident aliens who are women; (b) an enterprise in which the ownership interest of such women is real, substantial and continuing; (c) an enterprise in which such women ownership has and exercises the authority to control independently the day-to-day business decisions of the enterprise; (d) an enterprise authorized to do business in this state and independently owned and operated; (e) an enterprise owned by an individual or individuals, whose ownership, control and operation are relied upon for certification, with a personal net worth that does not exceed three million five hundred thousand dollars (\$3,500,000), as adjusted annually on the first of January for inflation according to the consumer price index of the previous year; and (f) an enterprise that is a

small business pursuant to subdivision twenty of this section.

A firm owned by a minority group member who is also a woman may be certified as a minority-owned business enterprise, a women-owned business enterprise, or both, and may be counted towards either a minority-owned business enterprise goal or a women-owned business enterprise goal, in regard to any Contract or any goal, set by an agency or authority, but such participation may not be counted towards both such goals. Such an enterprise's participation in a Contract may not be divided between the minority-owned business enterprise goal and the women-owned business enterprise goal.

MINORITY-OWNED BUSINESS ENTERPRISE herein referred to as "MBE", shall mean a business enterprise, including a sole proprietorship, partnership or corporation that is: (a) at least fifty-one percent (51%) owned by one or more minority group members; (b) an enterprise in which such minority ownership is real, substantial and continuing; (c) an enterprise in which such minority ownership has and exercises the authority to control independently the day-to-day business decisions of the enterprise; (d) an enterprise authorized to do business in this state and independently owned and operated; (e) an enterprise owned by an individual or individuals, whose ownership, control and operation are relied upon for certification, with a personal net worth that does not exceed three million five hundred thousand dollars (\$3,500,000.00), as adjusted annually on the first of January for inflation according to the consumer price index of the previous year; and (f) an enterprise that is a small business pursuant to subdivision twenty of this section.

MINORITY GROUP MEMBER shall mean a United States citizen or permanent resident alien who is and can demonstrate membership in one of the following groups: (a) Black persons having origins in any of the Black African racial groups; (b) Hispanic persons of Mexican, Puerto Rican, Dominican, Cuban, Central or South American of either Indian or Hispanic origin, regardless of race; (c) Native American or Alaskan native peoples having origins in any of the original peoples of North America. (d) Asian and Pacific Islander persons having origins in any of the Far East countries, South East Asia, the Indian Subcontinent or Pacific Islands.

CERTIFIED ENTERPRISE OR BUSINESS shall mean a business verified as a minority or women-owned business enterprise pursuant to section 314 of the Executive Law. A business enterprise which has been approved by the New York Division of Minority & Women Business Development ("DMWBD") for minority or women-owned enterprise status subsequent to verification that the business enterprise is owned, operated, and controlled by minority group members or women, and that also meets the financial requirements set forth in the regulations.

2. TERMS. The parties to the attached State Contract agree to be bound by the following provisions which are made a part hereof (the word "Contractor" herein refers to any party other than the University):

1(a) Contractor and its Subcontractors shall undertake or continue existing programs of affirmative action to ensure that minority group members and women are afforded equal employment opportunities without discrimination. For these purposes, affirmative action shall apply in the areas of recruitment, employment, job assignment, promotion, upgrading, demotion, transfer, layoff, or termination and rates of pay or other forms of compensation.

(b) Prior to the award of a State Contract, the Contractor shall submit an equal employment opportunity (EEO) policy statement to the University within the time frame established by the University.

(c) As part of the Contractor's EEO policy statement, the Contractor, as a precondition to entering into a valid and binding State Contract, shall agree to the following in the performance of the State Contract: (i) The Contractor will not discriminate against any employee or applicant for employment, will undertake or continue existing programs of affirmative action to ensure that minority group members and women are afforded equal employment opportunities without discrimination, and shall make and document its conscientious and active efforts to employ and utilize minority group members and women in its work force on State Contracts; (ii) The Contractor shall state in all solicitations or advertisements for employees that, in the performance of the State Contract, all qualified applicants will be afforded equal employment opportunities without discrimination; (iii) At the request of the University the Contractor shall request each employment agency, labor union, or authorized representative of workers with which it has a collective bargaining or other agreement or understanding, to furnish a written statement that such employment agency, labor union, or representative will not discriminate, and that such union or representative will affirmatively cooperate in the implementation of the Contractor's obligations herein.

(d) Except for construction contracts, prior to an award of a State Contract, the Contractor shall submit to the contracting agency a staffing plan of the anticipated work force to be utilized on the State Contract or, where required, information on the Contractor's total work force, including apprentices, broken down by specified ethnic background, gender, and Federal occupational categories or other appropriate categories specified by the contracting agency. The form of the staffing plan shall be supplied by the contracting agency. If Contractor fails to provide a staffing plan, or in the alternative, a description of its entire work force, the University may reject Contractor's bid, unless Contractor either commits to provide such information at a later date or

provides a reasonable justification in writing for its failure to provide the same.

(e) After an award of a State Contract, the Contractor shall submit to the University a workforce utilization report, in a form and manner required by the agency, of the work force actually utilized on the State Contract, broken down by specified ethnic background, gender, and Federal occupational categories or other appropriate categories specified by the University.

(f) The Contractor shall include the provisions of this section in every Subcontract in such a manner that the requirements of the provisions will be binding upon each Subcontractor as to work in connection with the State Contract, including the requirement that Subcontractors shall undertake or continue existing programs of affirmative action to ensure that minority group members and women are afforded equal employment opportunities without discrimination, and, when requested, provide to the Contractor information on the ethnic background, gender, and Federal occupational categories of the employees to be utilized on the State Contract.

(g) To ensure compliance with the requirements of this paragraph, the University shall inquire of a Contractor whether the work force to be utilized in the performance of the State Contract can be separated out from the Contractor's and/or Subcontractors' total work force and where the work of the State Contract is to be performed. For Contractors who are unable to separate the portion of their work force which will be utilized for the performance of this State Contract, Contractor shall provide reports describing its entire work force by the specified ethnic background, gender, and Federal Occupational Categories, or other appropriate categories which the agency may specify.

(h) The University may require the Contractor and any Subcontractor to submit compliance reports, pursuant to the regulations relating to their operations and implementation of their affirmative action or equal employment opportunity program in effect as of the date the State Contract is executed.

(i) If a Contractor or Subcontractor does not have an existing affirmative action program, the University may provide to the Contractor or Subcontractor a model plan of an affirmative action program. Upon request, the Director of DMWBD shall provide a contracting agency with a model plan of an affirmative action program.

(j) Upon request, DMWBD shall provide the University with information on specific recruitment sources for minority group members and woman, and contracting agencies shall make such information available to Contractors

2. Contractor must provide the names, addresses and federal identification numbers of certified minority- and women-owned business enterprises which the Contractor intends to use to perform the State Contract and a description of the Contract scope of work which the Contractor intends to structure to increase the participation by Certified minority- and/or women-owned business enterprises on the State Contract, and the estimated or, if known, actual dollar amounts to be paid to and performance dates of each component of a

State Contract which the Contractor intends to be performed by a certified minority- or woman-owned business enterprise. In the event the Contractor responding to University solicitation is joint venture, teaming agreement, or other similar arrangement that includes a minority- and women owned business enterprise, the Contractor must submit for review and approval: i. the name, address, telephone number and federal identification of each partner or party to the agreement; ii. the federal identification number of the joint venture or entity established to respond to the solicitation, if applicable; iii. A copy of the joint venture, teaming or other similar arrangement which describes the percentage of interest owned by each party to the agreement and the value added by each party; iv. A copy of the mentor-protégé agreement between the parties, if applicable, and if not described in the joint venture, teaming agreement, or other similar arrangement.

3. PARTICIPATION BY MINORITY GROUP MEMBERS AND WOMEN. The University shall determine whether Contractor has made conscientious and active efforts to employ and utilize minority group members and women to perform this State Contract based upon an analysis of the following factors:

(a) Whether Contractor established and maintained a current list of recruitment sources for minority group members and women, and whether Contractor provided written notification to such recruitment sources that contractor had employment opportunities at the time such opportunities became available.

(b) Whether Contractor sent letters to recruiting sources, labor unions, or authorized representatives of workers with which contractor has a collective bargaining or other agreement or understanding requesting assistance in locating minority group members and women for employment.

(c) Whether Contractor disseminated its EEO policy by including it in any advertising in the news media, and in particular, in minority and women news media.

(d) Whether Contractor has attempted to provide information concerning its EEO policy to Subcontractors with which it does business or had anticipated doing business.

(e) Whether internal procedures exist for, at a minimum, annual dissemination of the EEO policy to employees, specifically to employees having any responsibility for hiring, assignment, layoff, termination, or other employment decisions. Such dissemination may occur through distribution of employee policy manuals and handbooks, annual reports, staff meetings and public postings.

(f) Whether Contractor encourages and utilizes minority group members and women employees to assist in recruiting other employees.

(g) Whether Contractor has apprentice training programs approved by the N.Y.S. Department of Labor which provides for training and hiring of minority group members and women.

(h) Whether the terms of this section have been incorporated into each Subcontract which is entered into by the Contractor.

4. PARTICIPATION BY MINORITY AND WOMEN-OWNED BUSINESS ENTERPRISES. Based upon an analysis of the following factors, the University shall determine whether Contractor has made good faith efforts to provide for meaningful participation by minority-owned and women-owned business enterprises which have been certified by DMWBD:

(a) Whether Contractor has actively solicited bids for Subcontracts from qualified M/WBES, including those firms listed on the Directory of Certified Minority and Women-Owned Business Enterprises, and has documented its good faith efforts towards meeting minority and women owned business enterprise utilization plans by providing, copies of solicitations, copies of any advertisements for participation by certified minority- and women-owned business enterprises timely published in appropriate general circulation, trade and minority- or women-oriented publications, together with the listing(s) and date(s) of the publications of such advertisements; dates of attendance at any pre-bid, pre-award, or other meetings, if any, scheduled by the University, with certified minority- and women-owned business enterprises, and the reasons why any such firm was not selected to participate on the project.

(b) Whether Contractor has attempted to make project plans and specifications available to firms who are not members of associations with plan rooms and reduce fees for firms who are disadvantaged.

(c) Whether Contractor has utilized the services of organizations which provide technical assistance in connection with M/WBE participation.

(d) Whether Contractor has structured its Subcontracts so that opportunities exist to complete smaller portions of work.

(e) Whether Contractor has encouraged the formation of joint ventures, partnerships, or other similar arrangements among Subcontractors.

(f) Whether Contractor has requested the services of the Department of Economic Development (DED) to assist Subcontractors' efforts to satisfy bonding requirement.

(g) Whether Contractor has made progress payments promptly to its Subcontractors.

(h) Whether the terms of this section have been incorporated into each Subcontract which is entered into by the Contractor. It shall be the responsibility of Contractor to ensure compliance by every Subcontractor with these provisions.

5. GOALS. (a) GOALS FOR MINORITY AND WOMEN WORK FORCE PARTICIPATION.

(i) The University shall include relevant work force availability data, which is provided by the DMWBD, in all documents which solicit bids for State Contracts and shall make efforts to assist Contractors in utilizing such data to determine expected levels of participation for minority group members and women on State Contracts.

(ii) Contractor shall exert good faith efforts to achieve such goals for minority and women's participation. To successfully achieve such goals, the employment of minority group members and women by

Contractor must be substantially uniform during the entire term of this State Contract. In addition, Contractor should not participate in the transfer of employees from one employer or project to another for the sole purpose of achieving goals for minority and women's participation.

(b) **GOALS FOR MINORITY AND WOMEN-OWNED BUSINESS ENTERPRISES PARTICIPATION.** For all State Contracts in excess of \$25,000.00 whereby the University is committed to expend or does expend funds in return for labor, services including but not limited to legal, financial and other professional services, supplies, equipment, materials or a combination of the foregoing or all State Contracts in excess of \$100,000.00 whereby the University is committed to expend or does expend funds for the acquisition, construction, demolition, replacement, major repair or renovation of real property and improvements thereon, Contractor shall exert good faith efforts to achieve a participation goal of fourteen percent (14%) for Certified Minority-Owned Business Enterprises and twelve percent (12%) for Certified Women-Owned Business Enterprises.

6. ENFORCEMENT. The University will be responsible for enforcement of each Contractor's compliance with these provisions. Contractor, and each Subcontractor, shall permit the University access to its books, records and accounts for the purpose of investigating and determining whether Contractor or Subcontractor is in compliance with the requirements of Article 15-A of the Executive Law. If the University determines that a Contractor or Subcontractor may not be in compliance with these provisions, the University may make every reasonable effort to resolve the issue and assist the Contractor or Subcontractor in its efforts to comply with these provisions. If the University is unable to resolve the issue of noncompliance, the University may file a complaint with the DMWBD.

7. DAMAGES FOR NON COMPLIANCE.

Where the University determines that Contractor is not in compliance with the requirements of the Contract and Contractor refuses to comply with such requirements, or if Contractor is found to have willfully and intentionally failed to comply with the MWBE participation goals, Contractor shall be obligated to pay to liquidated damages to the University. Such liquidated damages shall be

calculated as an amount equaling the difference between:

- a. All sums identified for payment to MWBEs had the Contractor achieved the contractual MWBE goals; and
- b. All sums actually paid to MWBEs for work performed or materials supplied under the Contract.

In the event a determination has been made which requires the payment of liquidated damages and such identified sums have not been withheld by the University, Contractor shall pay such liquidated damages to the University within sixty (60) days after such damages are assessed, unless prior to the expiration of such sixtieth day, the Contractor has filed a complaint with the Director of the Division of Minority and Woman Business Development pursuant to Subdivision 8 of Section 313 of the Executive Law in which event the liquidated damages shall be payable if Director renders a decision in favor of the University.

Attachment 1
Bidder Proposer Information

YOU ARE INVITED TO SUBMIT A PROPOSAL FOR RFP SU-070213-2.
BID PROPOSERS MUST SUBMIT THE FOLLOWING:

1. a) A completed Bid Proposer Submission Form (this page);
b) State Finance Law §§ 139-j and 139-k Form B;
c) State Finance Law §§ 139-j and 139-k and Form C;
d) Form A (New York State Consultant services, Contractor's Planned Employment).
2. Information as requested in Part II: Detailed Specifications.
3. Your firm's Equal Employment Opportunity Policy Statement, which conforms to the provisions of Exhibit A-1.

IF YOU ARE NOT SUBMITTING A PROPOSAL, PCAC REQUESTS THE FOLLOWING:

1. Respond "No Proposal will be submitted" and state your reason(s).
2. Return only this page to the Issuing Office address on Page 1.

BIDDERS PLEASE RESPOND TO THE FOLLOWING INQUIRIES AND/OR CERTIFICATIONS:

1. Is the price quoted the same as or lower than that quoted other corporations, institutions or governmental agencies for similar services and/or like equipment or supplies?

YES: _____ NO: _____ If no, explain. _____

2. Does your firm agree that all presentations and materials will be free from racial, religious, or sexual bias?

YES: _____ NO: _____

3. Are you a New York State (NYS) resident business? YES: _____ NO: _____

4. Total number of people employed by firm: _____

5. Total number of people employed by firm in NYS: _____

6. Is your firm a NYS Minority-owned Business? YES: _____ NO: _____
NYS Certified? YES: _____ NO: _____

7. Is your firm a NYS Women-owned Business? YES: _____ NO: _____
NYS Certified? YES: _____ NO: _____

8. Please indicate if you or any officer of your organization, or any party owning or controlling more than 10 percent of your stock if you are a corporation, or any member if you are a firm or association, is an officer or employee of the State of New York or of a public benefit corporation of the State of New York. YES: _____ NO: _____

9. In accordance with State Finance Law §§ 139-j and 139-k, please certify that all information provided to Purchase College with respect to State Finance Law §§ 139-j and 139-k is complete, true and accurate.

FIRM'S NYS STATE FINANCIAL SYSTEM NUMBER (SFS ID): _____

FIRM'S TAX IDENTIFICATION NUMBER (TIN): _____

FIRM NAME: _____

ADDRESS: _____

TELEPHONE NUMBER: (_____) _____ FAX NUMBER: (_____) _____

E-MAIL ADDRESS: _____

FIRM REPRESENTATIVE - NAME / TITLE (printed) _____

FIRM REPRESENTATIVE SIGNATURE _____ DATE _____

Attachment 2
PCAC Enabling Legislation



Effective 8/15/11

Bill No.: A00340

Summary Actions Votes Memo Text

[Back](#)

[Bill Search & Legislative Information Home](#)

[Assembly Home](#)

[Bill / Floor Vote Search](#)

[New York State Laws](#)

[Legislative Calendar](#)

[Public Hearing Schedules](#)

[Assembly Calendars](#)

[Assembly Committee](#)

[Agenda](#)

A00340 Summary:

BILL NO A00340A
SAME AS Same as S 1846-A
SPONSOR Paulin (MS)
COSPNSR Spano, Lupardo, Castelli
MLTSPNSR Boyland

Authorizes the lease of lands located at the state university of New York at Purchase for a senior learning community.

[Go to top](#)

A00340 Text:

STATE OF NEW YORK

340--A

2011-2012 Regular Sessions

IN ASSEMBLY

(PREFILED)

January 5, 2011

Introduced by M. of A. PAULIN, SPANO, LUPARDO, CASTELLI -- read once and referred to the Committee on Higher Education -- committee discharged, bill amended, ordered reprinted as amended and recommitted to said committee

AN ACT to authorize the lease of lands located at the state university of New York at Purchase

THE PEOPLE OF THE STATE OF NEW YORK, REPRESENTED IN SENATE AND ASSEMBLY, DO ENACT AS FOLLOWS:

1 Section 1. Legislative findings. The legislature finds that the
2 provision of a senior learning community upon the grounds of the state
3 university of New York at Purchase is appropriate to further the objec-
4 tives and purposes of the state university of New York. The legislature
5 further finds that granting the trustees of the state university of New
6 York the authority and power to lease and otherwise contract to make
7 available grounds and facilities of the campus of the state university
8 of New York at Purchase will ensure the availability of such senior
9 learning community, and also promote the effective use of such grounds

10 and facilities.

11 S 2. The trustees of the state university of New York are hereby
 12 authorized to lease without any public bidding a portion of the lands of
 13 the state university of New York at Purchase generally described in this
 14 act to the Purchase college advancement corporation, a not-for-profit
 15 corporation, upon such terms and conditions as the trustees deem advis-
 16 able, for an initial term not to exceed forty years or for such time as
 17 may be necessary to complete repayment of any debt related to the
 18 projects described in this act, whichever is shorter. In the event that
 19 the real property which is the subject of such lease or contract shall
 20 ~~cease to be used for the purposes described in this act, said lease~~
 21 shall immediately terminate and the real property and any improvements
 22 thereon shall revert to the state university of New York. Any contract

EXPLANATION--Matter in ITALICS (underscored) is new; matter in brackets
 [] is old law to be omitted.

LBD02543-04-1

A. 340--A

2

1 or lease entered into pursuant to this act shall provide that the real
 2 property which is the subject of such lease or contract and any improve-
 3 ments thereon shall revert to the state university of New York upon the
 4 expiration of such lease. The description of the parcels to be leased
 5 pursuant to such section are not meant to be legal descriptions, but are
 6 intended only to identify the parcels and improvements to be leased for
 7 purposes consistent with the mission of the state university of New York
 8 at Purchase.

9 S 3. For the purposes of this act: (a) "project" shall mean work at
 10 the property authorized by this act to be leased to the Purchase college
 11 advancement corporation as described in section fourteen of this act
 12 that involves the design, construction, reconstruction, demolition,
 13 excavating, rehabilitation, repair, renovation, alteration or improve-
 14 ment of a senior learning community.

15 (b) "project labor agreement" shall mean a pre-hire collective
 16 bargaining agreement between a contractor and a labor organization,
 17 establishing the labor organization as the collective bargaining repre-
 18 sentative for all persons who will perform work on the project, and
 19 which provides that only contractors and subcontractors who sign a pre-
 20 negotiated agreement with the labor organization can perform project
 21 work.

22 S 4. Notwithstanding the provisions of any general, special, or local
 23 law or judicial decision to the contrary:

24 (a) The Purchase college advancement corporation may require a
 25 contractor awarded a contract, subcontract, lease, grant, bond, covenant
 26 or other agreement for a project to enter into a project labor agreement
 27 during and for the work involved with such project when such requirement
 28 is part of the Purchase college advancement corporation's request for
 29 proposals for the project and when the Purchase college advancement
 30 corporation determines that the record supporting the decision to enter
 31 into such an agreement establishes that the interests underlying the
 32 competitive bidding laws are best met by requiring a project labor
 33 agreement including: obtaining the best work at the lowest possible
 34 price; preventing favoritism, fraud and corruption; the impact of delay;
 35 the possibility of cost savings; and any local history of labor unrest.

36 (b) If the Purchase college advancement corporation does not require a
 37 project labor agreement, then any contractor, subcontractor, lease,
 38 grant, bond, covenant or other agreements for a project shall be awarded
 39 pursuant to section 135 of the state finance law.

40 (c) Any contract to which the Purchase college advancement corporation
 41 is a party, and any contract entered into by a third party acting in
 42 place of, on behalf of and for the benefit of the Purchase college
 43 advancement corporation pursuant to any lease, permit or other agreement
 44 between such third party and the Purchase college advancement corpo-
 45 ration, for a project deemed a public works project for the purposes of
 46 article 8 of the labor law, and shall be subject to all of the
 47 provisions of article 8 of the labor law, including the enforcement of

48 prevailing wage requirements by the fiscal officer as defined in para-
49 graph e of subdivision 5 of section 220 of the labor law to the same
50 extent as a contract of the state.

51 (d) Every contract entered into by the Purchase college advancement
52 corporation for a project shall contain a provision that the contractor
53 shall furnish a labor and material bond guaranteeing prompt payment of
54 moneys that are due to all persons furnishing labor and materials pursu-
55 ant to the requirements of any contracts for a project undertaken pursu-
56 ant to this section and a performance bond for the faithful performance
A. 340--A 3

1 of the project, which shall conform to the provisions of section 103-f
2 of the general municipal law, and that a copy of such performance and
3 payment bonds shall be kept by the Purchase college advancement corpo-
4 ration and shall be open to public inspection.

5 (e) For the purposes of article 15-A of the executive law, any indi-
6 vidual, public corporation or authority, private corporation, limited
7 liability company or partnership or other entity entering into a
8 contract, subcontract, lease, grant, bond, covenant or other agreement
9 for a project authorized pursuant to this section shall be deemed a
10 state agency as that term is defined in such article and such contracts
11 shall be deemed state contracts within the meaning of that term as set
12 forth in such article.

13 (f) Whenever the Purchase college advancement corporation enters into
14 a contract, subcontract, lease, grant, bond, covenant or other agreement
15 for a project undertaken pursuant to this act, the Purchase college
16 advancement corporation shall consider the financial and organizational
17 capacity of contractors and subcontractors in relation to the magnitude
18 of work they may perform, the record of performance of contractors and
19 subcontractors on previous work, the record of contractors and subcon-
20 tractors in complying with existing labor standards and maintaining
21 harmonious labor relations, and the commitment of contractors to work
22 with minority and women owned business enterprises pursuant to article
23 15-A of the executive law through joint ventures or subcontractor
24 relationships.

25 S 5. The Purchase college advancement corporation shall require that
26 whenever work is performed under this section, the contractors and
27 subcontractors shall have apprenticeship programs appropriate for the
28 type and scope of work to be performed, that have been registered with
29 and approved by the commissioner of labor pursuant to article 23 of the
30 labor law. Additionally, it must be demonstrated that the apprenticeship
31 program has made significant efforts to attract and retain minority
32 apprentices, as determined by affirmative action goals established for
33 such programs by the department of labor.

34 S 6. Whenever the Purchase college advancement corporation enters into
35 a contract under which employees are employed to perform building
36 service work, as that term is defined in section 230 of the labor law,
37 such work shall be subject to article 9 of the labor law to the same
38 extent as building services work performed pursuant to a contract with a
39 public agency.

40 S 7. Whenever employees perform work at the senior learning community
41 other than work performed under sections four and six of this act, such
42 employees shall be paid by their employer no less than the median hourly
43 wage for "all occupations" in the metropolitan statistical area closest
44 to the project location, published by the United States bureau of labor
45 statistics, for the duration of the lease term. All of the provisions
46 of article 9 of the labor law shall apply. Employers shall be subject to
47 the requirements of contractors under article 9 of the labor law.

48 S 8. All developers must have entered into an agreement with the labor
49 organization or organizations that is/are actively engaged in represent-
50 ing and attempting to represent food and beverage, housekeeping, or
51 other service employees in the state university of New York at Purchase
52 area that is valid and enforceable under 29 U.S.C. section 185(a) and
53 that prohibits any strikes, picketing or other economic interference
54 with such food and beverage, housekeeping, or other service operations
55 and ensures that any such operations that are conducted by contractors,

56 subcontractors, licensees, assignees, tenants or subtenants, shall be
A. 340--A 4

1 done under contracts enforceable under 29 U.S.C. section 185(a) contain-
2 ing the same provisions as specified above.

3 S 9. Notwithstanding any other provision of this act, an employer and
4 employee organization of the senior learning community may enter into an
5 agreement which shall: (1) confer jurisdiction of the New York state
6 employment relations board; (2) provide for participation in an agree-
7 ment for the designation of collective bargaining under subdivision 1 of
8 ~~section 705 of the labor law, commonly known as card check; and~~ (3)
9 impose no strike provisions as set forth in subdivision two of this
10 section. Upon execution of such an agreement by both parties containing
11 all of the provisions set forth in this subdivision, the agreement shall
12 be binding and enforceable against both parties.

13 S 10. Nothing in this act shall be deemed to waive or impair any
14 rights or benefits of employees of the state university of New York that
15 otherwise would be available to them pursuant to the terms of agreements
16 between the certified representatives of such employees and the state of
17 New York pursuant to article 14 of the civil service law; all work
18 performed on such property that would ordinarily be performed by employ-
19 ees subject to article 14 of the civil service law shall continue to be
20 performed by such employees.

21 S 11. Without limiting the determination of such terms and conditions
22 by said trustees, such terms and conditions may provide for leasing,
23 construction, reconstruction, rehabilitation, improvement, operation and
24 management of and provision of services and assistance and granting of
25 licenses, easements and other arrangements with regard to such grounds
26 and facilities by the Purchase college advancement corporation and
27 parties contracting with the Purchase college advancement corporation
28 and, in connection with such activities, the obtaining of financing,
29 whether public or private or secured (including but not limited to,
30 secured by leasehold mortgages and assignments of rents and leases), by
31 the Purchase college advancement corporation and parties contracting
32 with the Purchase college advancement corporation, for the purposes of
33 completing the projects described in this act.

34 Parcel C shall be leased for the development of not more than 385
35 units of a senior learning community.

36 S 12. Any contracts entered into pursuant to this act between the
37 Purchase college advancement corporation and parties contracting with
38 the Purchase college advancement corporation shall be awarded by a
39 competitive process.

40 S.13. (a) Any contracts or leases entered into by the state university
41 of New York or the Purchase college advancement corporation pursuant to
42 this act shall be subject to approval of the attorney general as to form
43 as well as by the director of the budget and the state comptroller. Any
44 and all proceeds relating to the leases authorized by this act shall be
45 allocated by the board of trustees for Purchase college, state universi-
46 ty of New York, in the following manner: seventy-five percent to the
47 student financial aid for students who are eligible to receive a tuition
48 assistance award or supplemental tuition assistance pursuant to section
49 667 or 667-a of the education law and twenty-five percent to support
50 additional full-time faculty positions.

51 (b) The trustees of the state university of New York shall, on or
52 before July first of each year that a lease of lands as authorized by
53 this act remains in effect, report to the governor, the temporary presi-
54 dent of the senate, the speaker of the assembly, the director of the
55 division of the budget, the senate finance committee, the assembly ways
56 and means committee and the higher education committees of the legisla-
A. 340--A 5

1 ture the following information: (i) all proceeds derived from any lease
2 authorized by this act with a description of how such proceeds have been
3 allocated that year under subdivision (a) of this section; (ii) the
4 amount of funds spent at the state university of New York at Purchase
5 for additional full-time faculty positions and the number of additional

6 faculty positions associated with such amount; and (iii) the amount of
 7 funds spent at the state university of New York at Purchase for student
 8 scholarships, the total number of students receiving such scholarships
 9 and the number of students receiving such scholarships within the
 10 following income, as defined in section 663 of the education law, cate-
 11 gories: (A) 0-20,000 dollars; (B) 20,001-40,000 dollars; (C)
 12 40,001-60,000 dollars; and (D) 60,001-80,000 dollars.

13 S 14. The property authorized by this act to be leased to the Purchase
 14 college advancement corporation is generally described as a parcel of
 15 real property with improvements thereon, consisting of approximately
 16 40.5 acres, situated on the campus of the state university of New York
 17 at Purchase. The description in this section of the land to be leased is
 18 not a legal description, but is intended only to identify the premises
 19 to be leased for purposes consistent with the mission of the state
 20 university of New York at Purchase:

21 Parcel C

22 ALL that plot, piece or parcel of land situate and being in the Town of
 23 Harrison, County of Westchester and State of New York, bounded and
 24 described as follows:

25 BEGINNING at a point at the southeasterly corner of the herein described
 26 Lease Parcel C, said point being located, N 80 51' 39" W 163.33 feet, N
 27 81 12' 39" W 4.91 feet, N 02 00' 00" W 407.31 feet and N 00 19' 17" E
 28 62.93 feet from the point of beginning of Parcel #1 as shown on a map
 29 entitled, "Department of Education, State University of New York, State
 30 University College at Westchester, Map #1, Parcels 1, 2 and 3", dated
 31 and filed in the office of the Department of Public Works, May 27, 1966;
 32 thence through Parcel #1 along the northerly and easterly side of West
 33 Road, N 79 50' 00" W 285.54 feet, northwesterly on a curve to the right
 34 of radius 743.00 feet, an arc length of 988.36 feet, having a chord
 35 bearing N 41 43' 30" W 917.09 feet, N 03 37' 00" W 178.77 feet, N 06
 36 55' 00" E 1326.17 feet and northwesterly on a curve to the left of radi-
 37 us 592.00 feet, an arc length of 172.61 feet, having a chord bearing N
 38 01 26' 11" W 172.00 feet to a point; thence leaving the easterly side
 39 of West Road and continuing through Parcel #1, N 77 18' 00" E 130.00
 40 feet, N 82 12' 00" E 140.00 feet, S 09 47' 00" E 364.83 feet, S 69
 41 00' 00" E 463.42 feet, S 00 02' 00" E 369.54 feet, S 27 40' 00" W
 42 194.81 feet, S 79 51' 00" E 154.52 feet, S 10 39' 00" W 325.93 feet, S
 43 03 48' 00" E 310.96 feet, S 04 45' 00" W 271.62 feet, S 01 38' 00" E
 44 142.45 feet and S 03 04' 00" W 311.20 feet to the point or place of
 45 beginning.

46 CONTAINING 40.05 ACRES OF LAND

47 S 15. The state university of New York shall not lease lands described
 48 in this act unless a contract is executed by the Purchase college
 49 advancement corporation or lessee for a project pursuant to this act
 50 within three years of the effective date of this act.

August 18
2011

51 S 16. Any lease or other agreement executed pursuant to this act shall
 52 include an indemnity provision whereby the lessee or sublessee promises
 53 to indemnify, hold harmless, and defend the lessor against all claims,
 54 suits, actions, and liability to all persons on the leased premises,
 55 including tenant, tenant's agents, contractors, subcontractors, employ-
 A. 340--A 6

1 ees, customers, guests, licensees, invitees, and members of the public,
 2 for damage to any such person's property, whether real or personal, or
 3 for personal injuries arising out of tenant's use or occupation of the
 4 demised premises.

5 S 17. Insofar as the provisions of this act are inconsistent with the
 6 provisions of any law, general, special or local, the provisions of this
 7 act shall be controlling; provided; however, that all leases, contracts,
 8 financing, granting of licenses, easements, and other arrangements with
 9 regard to a project pursuant to this act shall be subject to the
 10 provisions of article 8 of the environmental conservation law.

11 S 18. The state university trustees are hereby authorized and directed
 12 to designate and maintain a minimum of 80 acres of real property located
 13 within the boundaries of the campus of the state university of New York

14 at Purchase for permanent preservation as open space lands.

15 S 19. All real property included in section eighteen of this act shall
16 be maintained for one or more of the following purposes:

17 (a) open space lands and natural areas for maintaining plants, animals
18 and natural communities; and

19 (b) an area of natural or historic interest and beauty which provides
20 the public with passive recreational opportunities.

21 S 20. (a) The state university trustees shall cause to be undertaken a
22 survey of the real property included in section nineteen of this act.
23 Such survey shall be completed and made available to the legislature and
24 the public not later than six months after the effective date of this
25 act.

FEB 18, 2012

26 (b) The state university trustees shall develop, in consultation with
27 the department of environmental conservation, a stewardship plan for the
28 maintenance of the real property included in section nineteen of this
29 act as open lands. Such plan shall be completed and made available to
30 the public not later than six months after the effective date of this
31 act.

FEB 18/2012

32 S 21. (a) Any contract or leases entered into by the state university
33 of New York or the Purchase college advancement corporation pursuant to
34 this act shall provide that not less than 20 percent of the units in the
35 senior learning community must, upon the initial rental of the units and
36 upon all subsequent rentals of the units after a vacancy, be affordable
37 to and occupied or available for occupancy by individuals or families
38 whose incomes at the time of initial occupancy do not exceed 80 percent
39 of the median household income for the county of Westchester as calcu-
40 lated by the United States census bureau.

41 (b) All affordable units must be geographically integrated with the
42 market rate units and residents of such units shall be provided with and
43 have access to the services and amenities available to other residents
44 in the development.

45 (c) Residents of the county where the development is located shall
46 have priority for the rental of 50 percent of the affordable units,
47 provided they meet the income requirements of this section.

48 S 22. This act shall take effect immediately.

[Go to top](#)

Attachment 3
Vicinity Map



0 2 miles

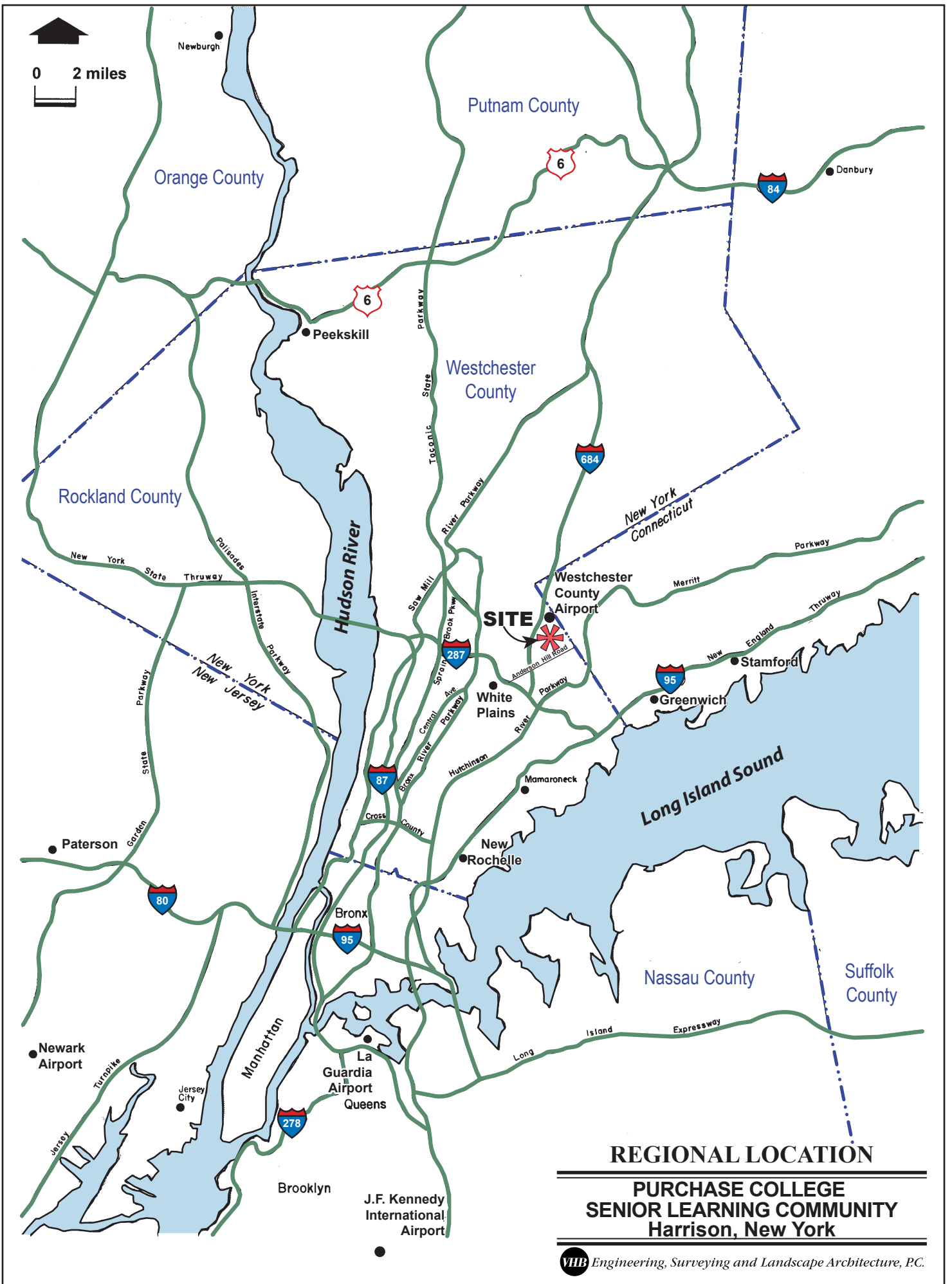

REGIONAL LOCATION

**PURCHASE COLLEGE
SENIOR LEARNING COMMUNITY
Harrison, New York**

Attachment 4
Aerial and Topographic Maps

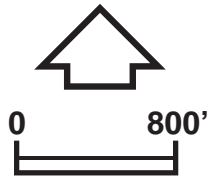
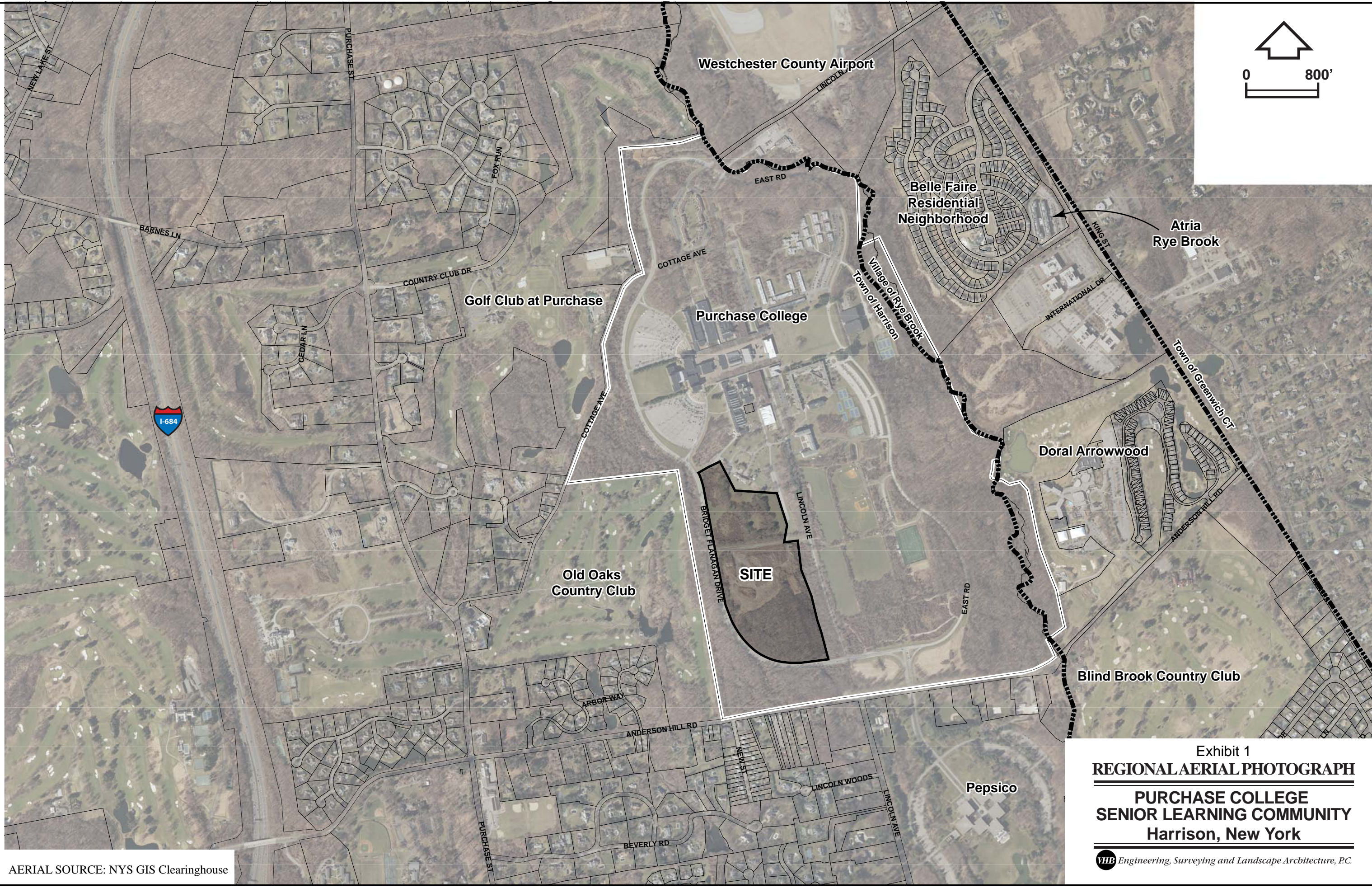

Westchester County Airport

Belle Faire Residential Neighborhood

Atria Rye Brook

Golf Club at Purchase

Purchase College

Village of Rye Brook
Town of Harrison

Town of Greenwich CT



Doral Arrowwood

Old Oaks Country Club

SITE

Blind Brook Country Club

Pepsico

Exhibit 1
REGIONAL AERIAL PHOTOGRAPH

**PURCHASE COLLEGE
SENIOR LEARNING COMMUNITY
Harrison, New York**

VIB Engineering, Surveying and Landscape Architecture, P.C.



Exhibit 2
AERIAL PHOTOGRAPH
PURCHASE COLLEGE
SENIOR LEARNING COMMUNITY
Harrison, New York

VHB Engineering, Surveying and Landscape Architecture, P.C.

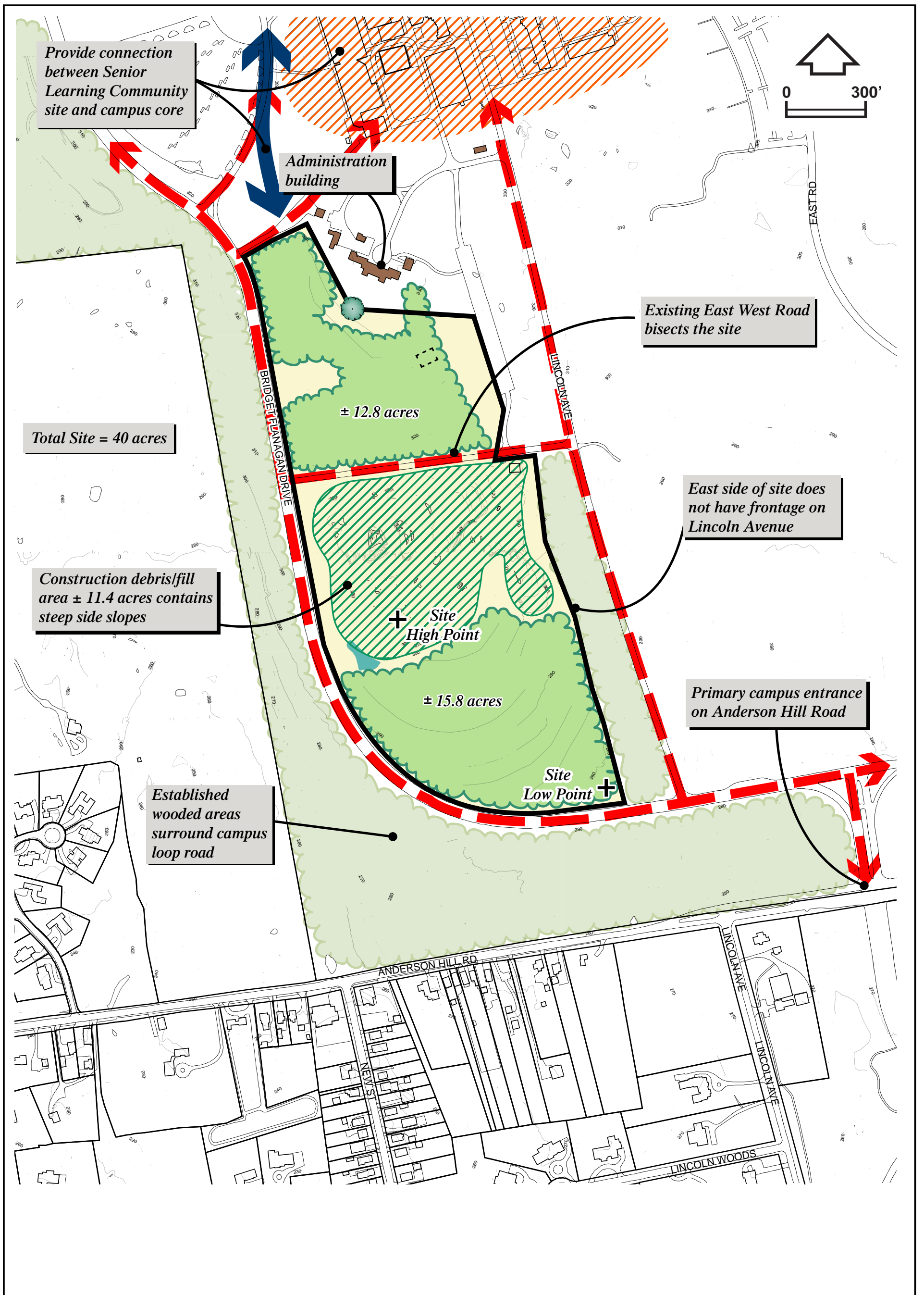

Exhibit 3
**SITE OPPORTUNITIES AND
 CONSTRAINTS**

**PURCHASE COLLEGE
 SENIOR LEARNING COMMUNITY
 Harrison, New York**

Attachment 5
Utility Report

MEMORANDUM

TO: Wayne Rush, P.E.

DATE: December 19, 2012

FROM: Gerhard Schwalbe, P.E.

RE: **SUNY Purchase
Senior Housing Project
Purchase, New York**

We have completed our initial findings regarding the utility availability and development constraints for the 40-acre site planned for senior housing. It is our understanding that the project will be developed on two sites within the 40-acre site with up to 385 senior housing units.

Water Supply

Water supply to the campus is obtained from a connection to a 16-inch public water main located in Anderson Hill Road to an underground meter assembly vault located northwest of the Lincoln Avenue and Anderson Hill Road intersection. Water supply is provided by Westchester Joint Water Works who obtains its water sources from the upstate Catskill and Delaware watersheds of the New York City water supply system. WJWW maintains two connections from the New York City system, one is from a connection at Shaft 22 and the other is taken from Rye Lake. WJWW is in negotiations with Westchester County to utilize a new pipe connection from the NYCDEP filtration plant located in Eastview so as to avoid the need to construct a new water filtration plant. It is not known if the costs associated with the improvements will impact the water rates for the College. According to the 2011 Annual Water Quality Report for 2011, WJWW purchased 4.55 billion gallons and sold 4.07 billion gallons to consumers.

SUNY Purchase utility records for a 24 month period from October 2010 through October 2012 show average water consumption for the campus to be approximately 6.1 million gallons per month or 203,000 gallons per day. Peak usage varies with a maximum monthly usage of 10.1 million gallons recorded during the month of February of 2012. It is not known why a high amount of water was used during that month as all other months in the winter ranged between 5 million to 6 million gallons per month. No water shortage events have been reported however reports of low pressure in the campus have been reported during the mid to late morning hours when school is in session. Some buildings in the campus are also equipped with fire booster pumps to provide higher pressure and fire flow. Hydrant flow tests provided indicate there is sufficient fire flow in the vicinity of the project site however there is drop in hydrant flow at the furthest end of the water main system indicating the system is not able to maintain constant pressure in all areas of the campus.

Using NYSDEC standards, projected usage for 385 two bedroom senior housing units has been estimated average to be approximately 93,000 gallons per day with an additional water usage of 31,000 gallons per day for the proposed dining hall, retail and pool facilities totaling the project water usage of

approximately 124,000 gallons per day. Although these estimated flows are considered conservative and actual consumption will be less, this amount represents an approximately 61% increase in total consumption used on campus. It has also been reported an additional 100 bedroom dormitory may be constructed on campus adding approximately 7,500 gallons per day. While it is not anticipated that the additional domestic water consumption will cause any significant impact on the campus system both fire demand and/or unusual flow demands occurring during the peak usage on the campus should be evaluated to determine if other improvements may be required to support the increased usage.

As shown in Figure No. 1, Water Service to the senior housing site can be made with a wet tap connection to the 16-inch main located in Lincoln Avenue immediately north of East-West Road. It is recommended that a water main loop along the westerly portion of the property reconnecting back to the existing 16-inch water main with a wet tap at the south intersection of Lincoln Avenue and Brigid Flanagan Drive. This will improve water flow through the project site and reduce stagnant water at pipe dead ends.

Although no communication has been made to Westchester Joint Water Works (WJWW), there does appear to be some concern regarding operating pressures within the campus and the additional peak flow demand may require improvements to the campus water system. It is recommended that the proposed project conduct additional water flow tests on the campus system once a determination of needed fire flow and peak water usage from consumption, irrigation and mechanical systems has been made. It is recommended that the design of the senior housing project consider native plantings to reduce the need for irrigation systems and mechanical systems that do not rely on extensive water use to reduce the impact on the campus water system.

Sanitary Sewer Service

Sanitary sewer service is provided to the campus from sewer mains owned and maintained by SUNY. The sewer system is connected to an 18-inch Westchester County Trunk Sewer that lies along the eastern boundary of the campus and flowing southward along the Blind Brook. Other than normal maintenance and occasional pipe clogs, no issues have been reported. The estimate sanitary flow for the project is estimated to be 113,000 gallons per day.

As shown in Figure No. 2, because the senior housing site is situated at an elevation lower than the main campus, a new sewer main will be required from the housing site extending south along the eastern property boundary and continuing easterly along the north grass area of Brigid Flanagan Drive. Approximately 3,900 LF feet of a new 8 inch SDR- 35 PVC pipe would have sufficient capacity for the project. Trenching for the sewer pipe and manhole installation may require excavation up to 12-14 feet deep along Brigid Flanagan Drive to reach the manhole located on the Blind Brook Trunk Sewer at the eastern end of the campus property.

Westchester County Department of Environmental Facilities (WCDEF) will need to be contacted to verify the capacity of their trunk sewer to accommodate the new sewer connection.

Alternatively a new sewage pump station could be constructed on the southern parcel with a force main connection to the main campus sewer to the north that would not require a new connection to the county trunk sewer.

The final layout of the new sewer main for the proposed development may change due to existing site and environmental conditions. Soil borings will be necessary to verify soil conditions and support for the pipe and manholes.

Stormwater Management

The stormwater management plan will be required to meet the requirements of SPDES General Permit for Stormwater Discharges - GP 0-10-001, and the New York State Stormwater Management Design Manual, August 2010. The project will be required to provide stormwater management practices to meet the Water Quality Volume, Runoff Reduction Volume, and Channel Protection Volume as well as maintain the peak runoff rates at or below existing levels for the 10-year and 100-year storm. Additional measures to protect the landfill from erosion and groundwater control may also be required by NYSDEC.

The development site is located on the southwestern portion of the Purchase College Campus. The site is mostly undeveloped consisting of wooded, brush, and grass area. The site drains to the south, to off-site streams that are tributary to Blind Brook. Blind Brook flows south through Harrison and the city of Rye to Milton Harbor of the Long Island Sound.

The stormwater management plan is to comply with the stormwater requirements through a series of Standard Management Practices (SMP) and Green Infrastructure (GI) techniques. The stormwater concept will be to treat the stormwater runoff at the source as much as possible through a series of rain gardens, porous pavement, vegetated swales and other GI techniques. Additional stormwater features to meet the water quality and detention requirements will be located around the perimeter of the development site. These SMPs can include bio-retention basins and wet extended detention basins equipped with control structures.

Assuming a development area of approximately 20 acres and an impervious cover of 50%, it is anticipated the volume of Stormwater storage needed is approximately 180,000 CF. Figure No. 3 illustrates the location of stormwater basins on the project site. Alternatively the basins could be placed outside the development area to allow for maximum development potential in the project site.

Electric Service

It would appear that the existing high voltage 15 KV feeders serving the Campus will have capacity to serve the new electrical loads associated with the new Senior Housing Project. Once contact with Con Edison is allowed to occur, the capacity of the utility system will be confirmed and a design concept can be developed.

Using standard design practices, current planning for the electric service anticipates a new high voltage automatic transfer switch (ATS) to provide normal service from one feeder and alternative service from the secondary feeder, when the normal feeder system is not available. A pad mounted transformer will be placed behind the transfer switch to serve the project.

The ATS should be located near the roadway, in an area that can be screened but remain accessible to

Con Ed as shown on Figure No. 4 with an extension of a single primary feeder from the ATS to a new transformer pad area. The accompanying graphics showing the schematic layout of the electrical system show the high voltage switchgear on the opposite side of the Lincoln Avenue from the development sites. We sited the high voltage equipment at this location to minimize the visual impacts to the development site, and we suggest it could be screened with a stone wall and plantings to match the Lincoln Avenue environs. The pad mounted transformer would be located as close to the main building sites as possible to minimize the length of the secondary conductors and associated higher costs of construction of heavier secondary cables. The ATS can also be located adjacent to the transformer if greater protection of the feeder system is required by the Senior Housing Project. The ATS and pad mounted transformer are typically provided by Con Edison with the cost passed on to the electric customer, in this case the Senior Housing Project. Con Ed may elect to require the customer to provide the ATS in accordance with all requirements of Con Edison and all costs for the ATS will be direct to the Senior Housing Project.

The electric service should be sub-metered to track electric costs and payments for electric consumption due from the Senior Housing Project to SUNY Purchase. Fees associated with the sub-metering are allowed to be passed on to the user, with a minor adjustment for administrative fees.

In the event Con Ed finds the primary feeders do not have capacity and requires a new dual 15KV feeder line routed to Anderson Hill Road the line would be required to be placed underground. The capacity and condition of the primary feeders should be reviewed early on with Con Edison so as to identify all costs associated with bringing service to the project site.

Natural Gas

It is reported that a 16-inch high pressure main exists in Lincoln Avenue and that main serves the SUNY Purchase Campus. At this time, it is anticipated that the lateral for the Senior Housing Project will be derived from the gas main in Lincoln Avenue and will be extended to a high pressure regulator and metering assembly constructed in accordance with Con Edison's required standards.

Con Edison bases the regulator sizes on the actual equipment being supplied, and typically only provides the minimum pressure required to serve the pressure and flows associated with the equipment listings. If the Developer elects to utilize a higher pressure piping systems to minimize piping costs and if a booster is required to achieve this high pressure; then all of the costs of the booster system are by the Developer. Developer should be instructed to not rely on Con Edison to provide natural gas pressures above the listings of the equipment.

The gas meter rig and assembly must be accessible by Con Edison, and will be constructed and operated in accordance with Con Edison's standards, specifications and engineering requirements.

As with electric service, Con Edison should be consulted early in the process to verify service capacity to the site.

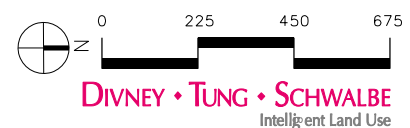
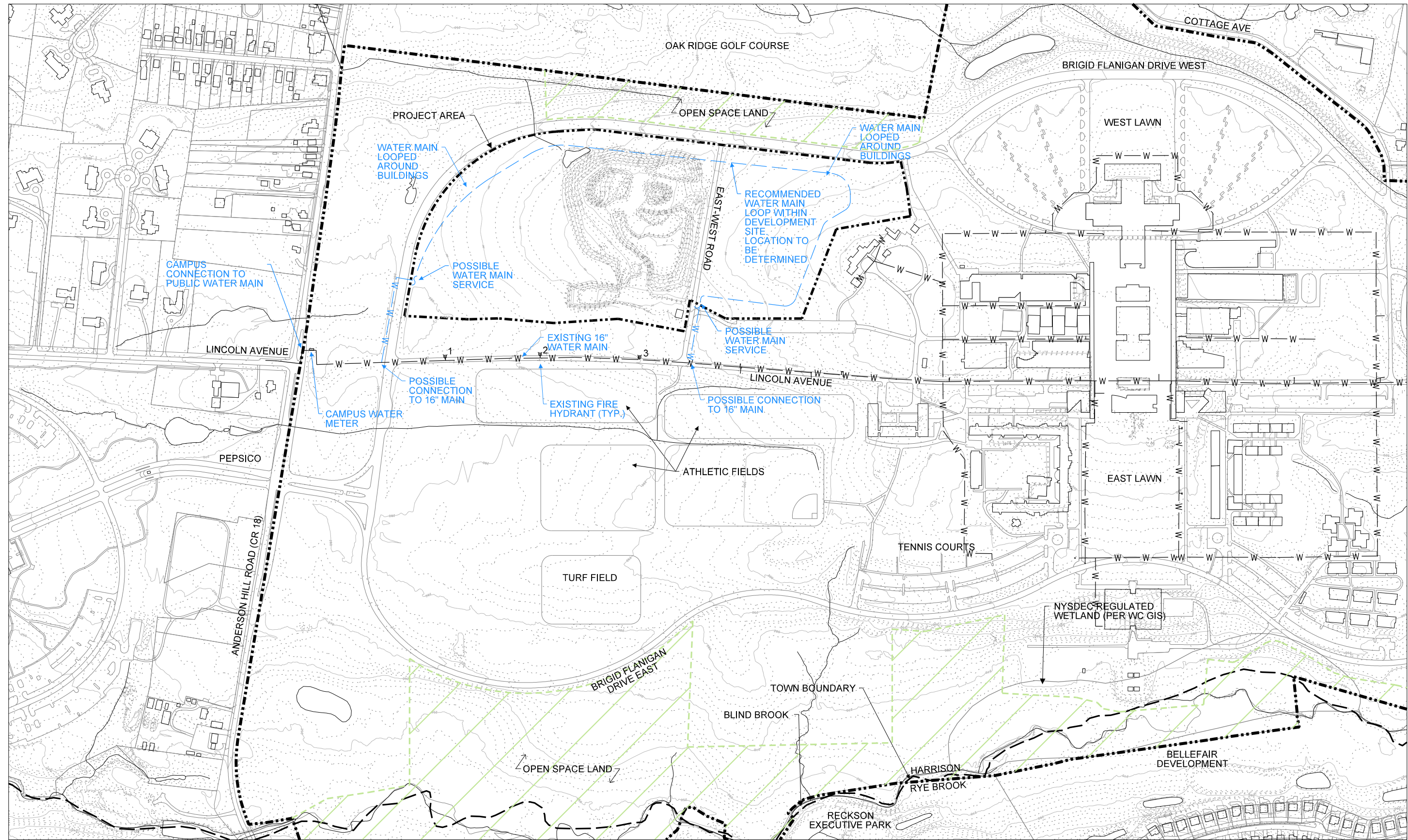

HYDRANT FLOW TEST (2012)

1	2417 GPM @ 54 PSI
2	2439 GPM @ 55 PSI
3	2417 GPM @ 54 PSI

WATER SUPPLY
 SENIOR LEARNING COMMUNITY
 PURCHASE COLLEGE, HARRISON, N.Y.
 STATE UNIVERSITY OF NEW YORK

FIGURE NO. 1
 12/19/2012

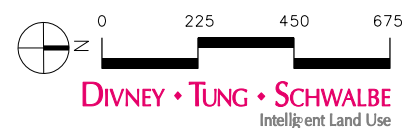
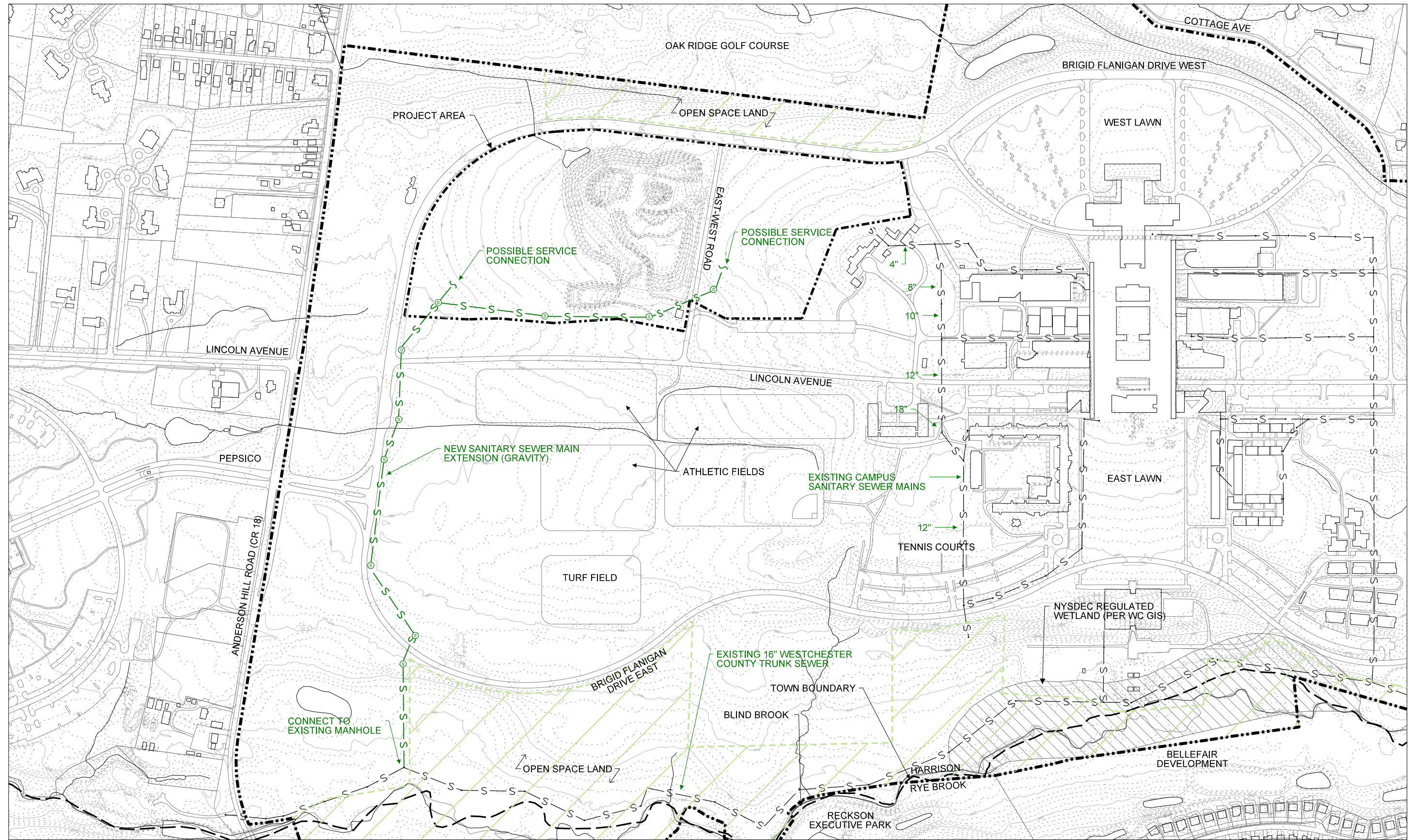

SANITARY SEWER SERVICE
SENIOR LEARNING COMMUNITY
PURCHASE COLLEGE, HARRISON, N.Y.
STATE UNIVERSITY OF NEW YORK

FIGURE NO. 2
12/19/2012

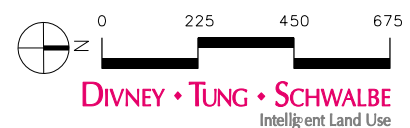
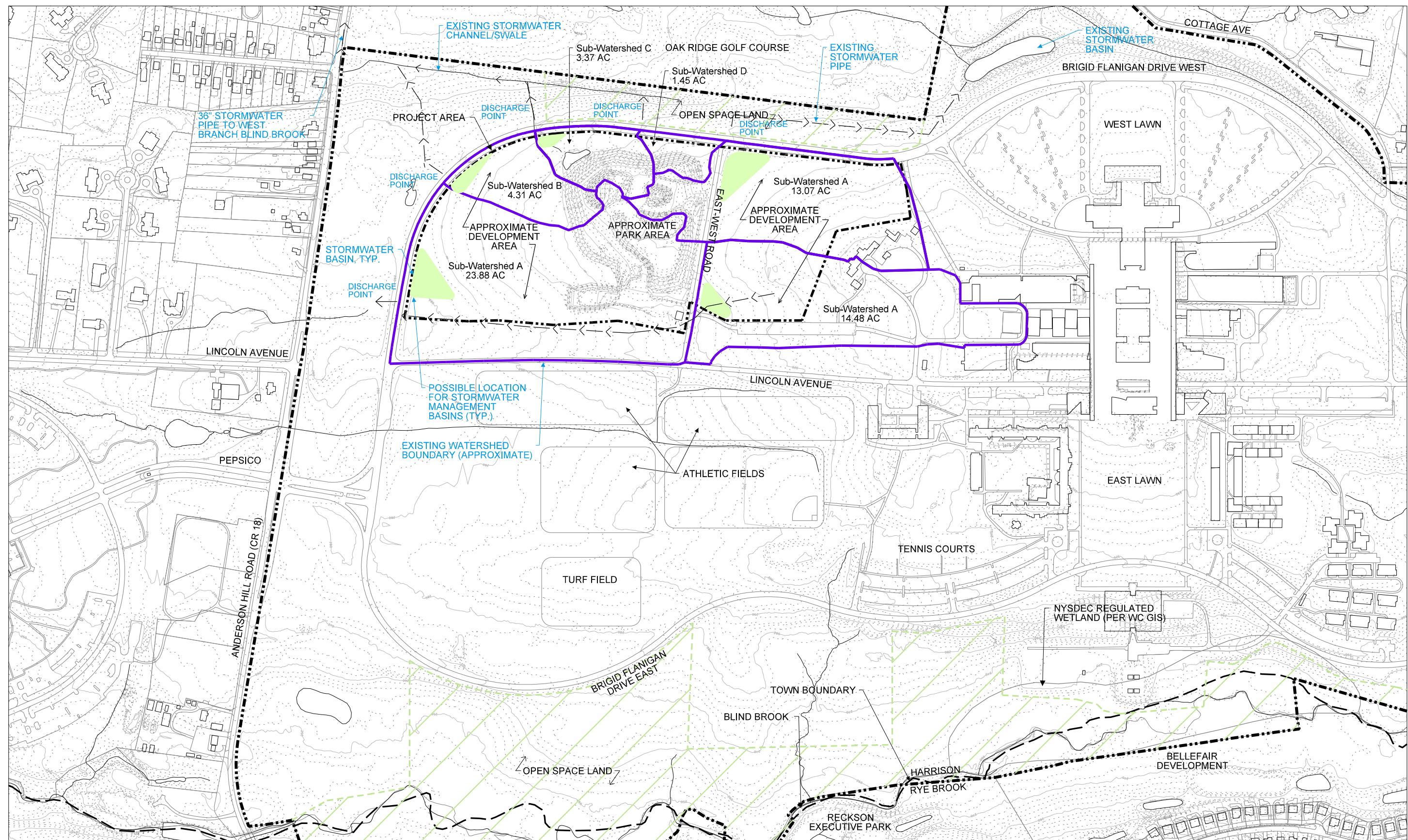

STORMWATER CONCEPT
 SENIOR LEARNING COMMUNITY
 PURCHASE COLLEGE, HARRISON, N.Y.
 STATE UNIVERSITY OF NEW YORK

FIGURE NO. 3
 12/19/2012

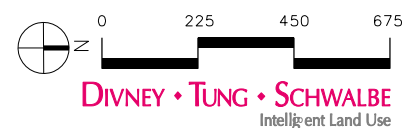
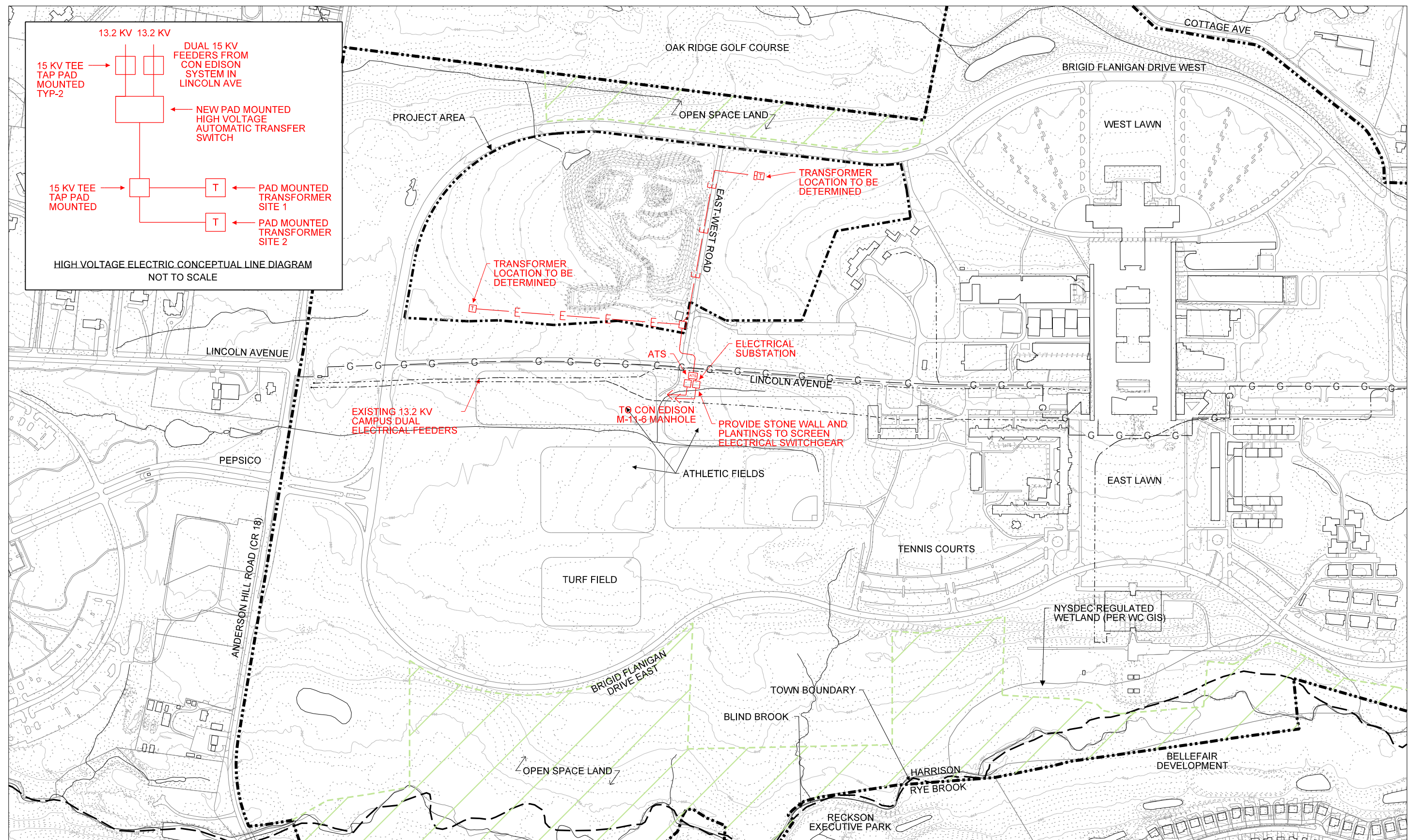
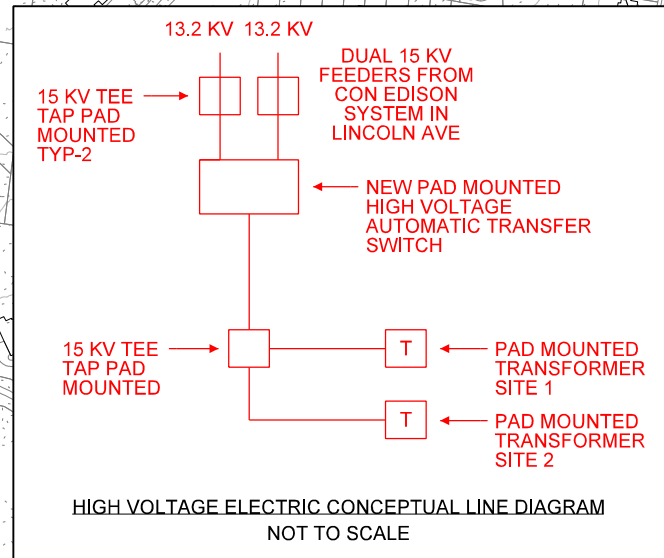

ELECTRIC SERVICE
SENIOR LEARNING COMMUNITY
PURCHASE COLLEGE, HARRISON, N.Y.
STATE UNIVERSITY OF NEW YORK

FIGURE NO. 4
12/19/2012

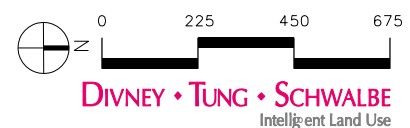
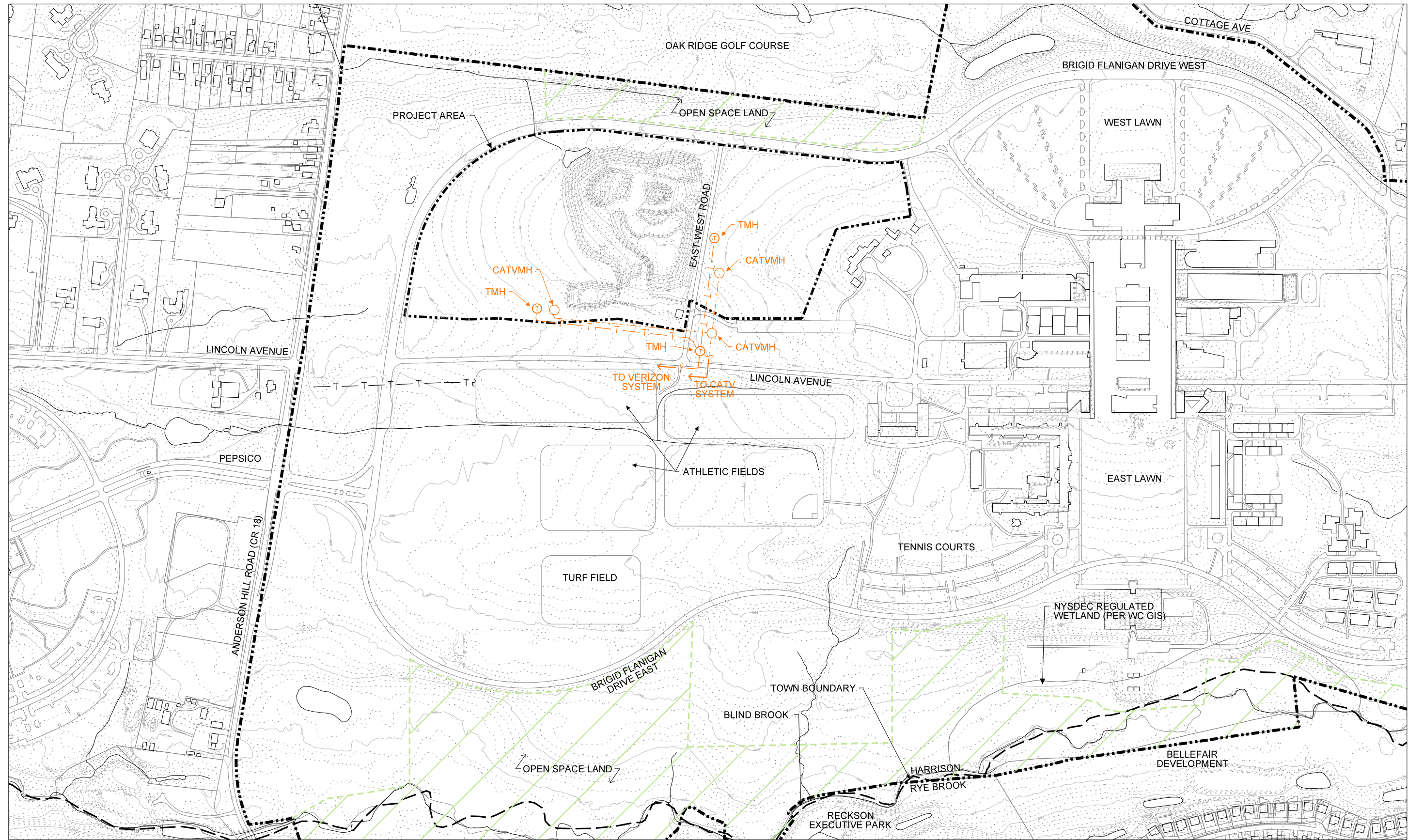

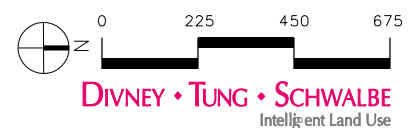
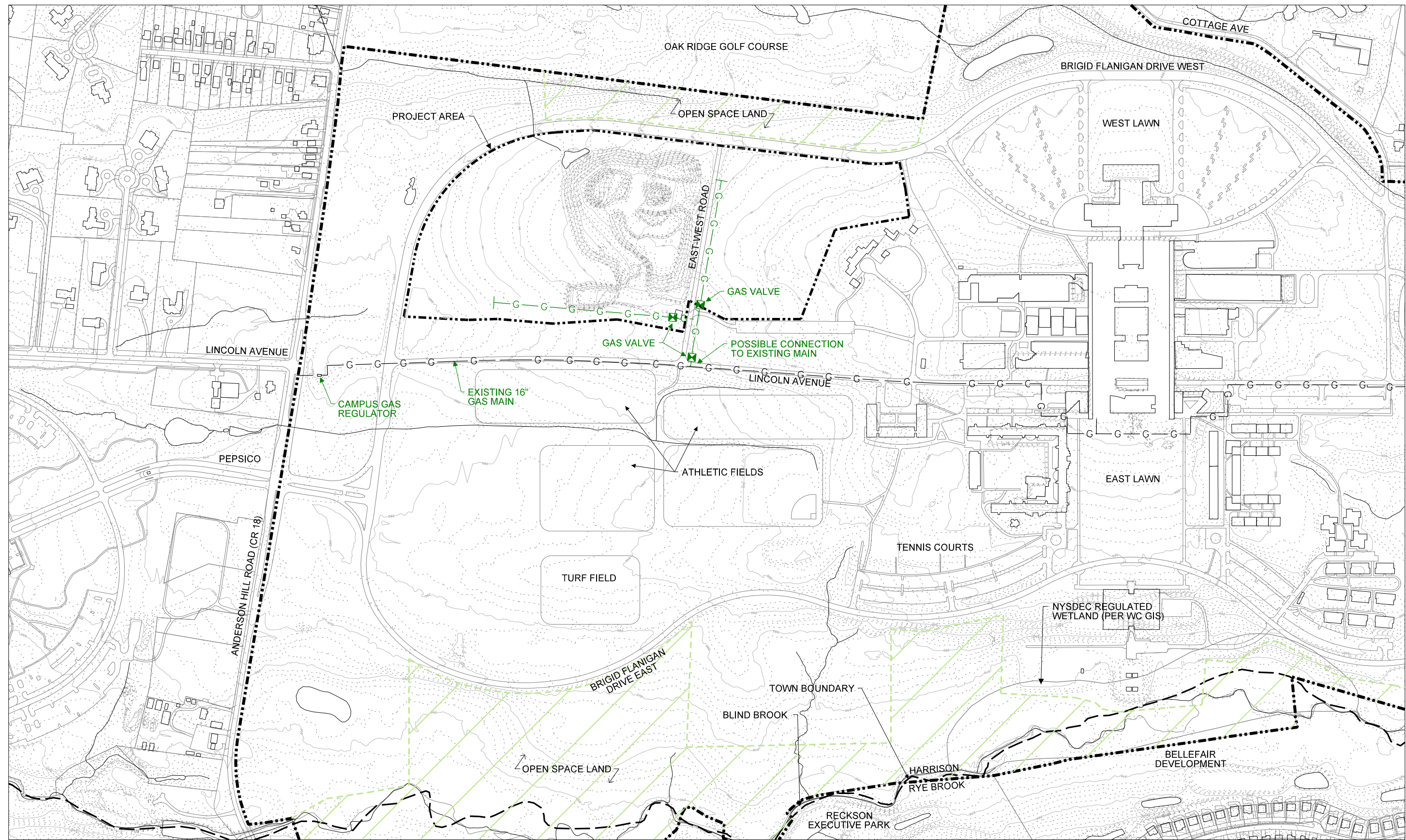

GAS SERVICE

SENIOR LEARNING COMMUNITY
PURCHASE COLLEGE, HARRISON, N.Y.
STATE UNIVERSITY OF NEW YORK

FIGURE NO. 6
12/19/2012

Attachment 6
Preliminary Geotechnical and Environmental Engineering Report

**PRELIMINARY GEOTECHNICAL AND
ENVIRONMENTAL ENGINEERING REPORT**

**SUNY Purchase College
735 Anderson Hill Road
Purchase, New York 10577**

PREPARED FOR:

Purchase College Advancement Corporation
SUNY Purchase College
735 Anderson Hill Road
Purchase, New York 10577

PREPARED BY

SESI Consulting Engineers, PC
12A Maple Avenue
Pine Brook, NJ 07058

Job No.: N-8306

DATE:

December 14, 2012

Justin M. Protasiewicz, EIT
Project Engineer

Michael St. Pierre, P.E.
Vice President
NY Lic. No. 080271

SITE DESCRIPTION

We have completed our preliminary geotechnical and environmental investigation for the existing Construction and Demolition (C&D) debris landfill located at the above referenced site. The purpose of our investigation was to obtain preliminary geotechnical and environmental information on the landfill to assist in the evaluation of the landfill closure and to provide recommendations for future development. The 20± acre landfill site is located in the north half of Lease Parcel C which encompasses an approximate 40.05± acre rectangular shaped lot bounded by East-West Road to the north, Lincoln Avenue to the east, and West Avenue, which wraps around the parcel to the South and West.

Based on our observations and a review of "Topographic Survey of Lease Parcel 'C'," developed by Chazen Engineering and Land Surveying Company, latest revision dated June 18, 2004, the landfill materials appear to have been stockpiled haphazardly throughout the landfill area, with lower elevations in the east side of the landfill ranging from 305± to 320± and rising steeply toward the west to an elevation of 364± at its high point. There are several localized high points within the larger landfill area. Several access roads are present throughout the landfill. Most of the landfill is currently covered by low vegetation, although there are some larger trees also present.

Based on a plan entitled, "Revised Topography," by Martin O'Grady & Associates, dated January 1974 (copy included in the Appendix), the site topography prior to the landfilling operations ranged from 315± to 317± adjacent to the center of East-West Road and the grades gradually sloped downwards from north to south where the elevations ranged from 293± to 295±. The landfill thicknesses, based on interpolation of the original and historical topography, are approximately 64± feet at the thickest point in the southwest side of the landfill to approximately 5± feet at the thinnest point in the northeast side of the landfill.

History

This historical summary of the SUNY Purchase landfill was derived from letters/reports provided by you dating back to 2001. According to an Order of Consent from the New York State Department of Environmental Conservation (NYDEC), dated April 20, 2001, the landfill was originally created as a result of a "Letter Agreement dated September 18, 1999," in which the companies Westway Industries, Inc. and its partner and subsidiary companies (Fairways F.T., Inc. and SDS Materials), who would serve as the "general contractor of the fill project, so as to ensure proper construction and handling of the fill project," was permitted to dump approximately 100,000 cubic yard of clean fill at the site. The consent order states that during the NYDEC inspections of the site on March 3, 2000, August 8, 2000, and September 21, 2000, Westway was found in violation of 6NYCRR Part 360-1.7(a)(i) by operating a solid waste management facility (non-exempt construction and demolition debris landfill) without a permit or other form of authorization. The Order of Consent prescribed specific requirements needed to remedy the situation and provide proper closure of the landfill. These requirements included submitting a Landfill Closure Plan, obtaining a Bond and submitting a Post Closure Monitoring and Maintenance Manual. It also included specific dates for starting and completing the landfill closure.

Based on review of a subsequent letter from the NYDEC to SUNY dated April 29, 2004, it appears that material continued to be accepted at the landfill, at least until the summer of 2002. In addition, dredge spoils were imported in the spring and summer of 2002 under a beneficial use determination (BUD); however, the DEC reported that this material was discharging an orange colored liquid into the surrounding wetland. According to the letter dated April 29, 2004, the NYDEC inspection of the material that was stockpiled onsite under the BUD did not meet the BUD criteria and would also be considered part of the landfill and must be remediated as such.

Based on notes from a meeting on May 11, 2004 at the NYSDEC regional office in Tarrytown, NY, SUNY indicated that they would be altering the Landfill Closure Plan since they wanted to pursue a different development option. The DEC indicated that a new closure plan would need to be submitted. In addition, if the C&D materials were to be processed for sale, a permit would be required under DEC regulations in Part 360. The DEC also indicated that additional testing of the materials would be required and a Beneficial Use Determination (BUD) would also be required.

Based on a letter dated June 16, 2004 from the NYDEC to SUNY, Fairways, F.T., Inc. reportedly submitted a closure plan prior to 2004 which contained plans for contouring of the landfill material to create a bowl-shaped area that would provide a foundation for construction of an amphitheater. As part of the closure plan, the NYDEC required a low permeability final cover/capping system to be installed over the entire landfill to mitigate any potential impacts on human health and the environment. As a result of Fairways non-compliance, SUNY told the NYSDEC that they had decided to move forward with remediation of the landfill independently of Fairways. Construction of a residential development on the landfill was discussed with the DEC who indicated that such a development would increase the risk of human exposure to the landfill materials. Processing the C&D material for a beneficial reuse was also discussed at this time. Four (4) alternatives for the landfill closure were discussed at the May 11, 2004 conference and summarized in the letter dated June 16, 2004. A generalized summary of the four (4) alternatives presented by the NYSDEC was:

1. Close the landfill according to an approved Engineering Plan. This would result in the implementation of institutional and engineering controls and continued monitoring of the landfill.
2. Completely remove the landfill without processing any of the fill materials. This would allow unrestricted use of the site.
3. Process some of the salvageable construction and demolition waste such as concrete, brick, rock, etc. for reuse and close/cap the landfill with the remaining materials left in-place and monitor using necessary institutional and engineering controls. A Beneficial Use Determination would be necessary for the material and institutional and engineering controls would also be necessary for the processed materials in addition to those for the landfill to prevent human exposure and migration of any residual contaminants to the surrounding soils and groundwater. This would result in the implementation of institutional and engineering controls and continued monitoring of the landfill.
4. Same as Alternate #3, however the remaining landfill materials would be removed. This would allow unrestricted use of the site.

In a letter dated July 1, 2004, from Gannett Fleming (GF) to SUNY, GF reviewed the four (4) alternatives provided by the NYDEC for reuse and closure of the landfill. GF recommended that SUNY pursue Alternate 4 or a combination of 3 and 4. GF made recommendations for further geotechnical and environmental investigations to determine the amount of C&D material in the landfill that could be processed and determine the environmental constraints of the material.

In a letter dated August 5, 2004, SUNY notified the DEC of its intent to proceed with Alternative 4 – waste processing and complete removal of the landfill in an attempt to achieve unrestricted use of the site. It further stated that a small-scale feasibility study was to be undertaken to determine the volume of recognizable C&D materials that could be processed. A final determination would be made based on the results of this study.

GF subsequently performed a limited investigation of a small portion of the landfill (western side) on August 12 and 13, 2004. Their study included excavating 26 test pits and passing the excavated materials through a 2-inch mesh screen to determine the amount of C&D materials present within the test pit. Environmental samples were also taken of the fines for laboratory testing. Their investigation determined that there was between 20 and 80% C&D debris within the area investigated. They concluded that the C&D materials could be processed and reused with a BUD to reduce the landfill volume by approximately half; however, because some of the sampling yielded exceedances of SVOC's and metals, the disposal of fill would likely be limited to 6NYCRR Part 360 permitted facilities (landfills). It should be noted that their investigation was confined to only a small portion of the entire landfill and they did not excavate to the full depth of the landfill. It is also not clear if they performed any environmental testing of the dredge spoils.

We have not been provided with any additional correspondence or documentation regarding the landfill since GF's investigation in 2004.

FIELD AND LABORATORY INVESTIGATIONS

As previously indicated, Gannett Fleming performed a limited geotechnical and environmental investigation on August 12 and 13, 2004. During their investigation, GF excavated a total of twenty-six (26) test pits to a maximum depth of 20± feet below grade. The materials in each test pit were screened by a geologist from GF to determine the quantities of C&D debris and fines. Samples of the fines were collected and analyzed for Volatile Organic Compounds (VOC's), Semi-Volatile Organic Compounds (SVOC's), Metals, and Polychlorinated Biphenyls (PCB's). Results of their environmental testing will be discussed later in this report and a copy is included in the Appendix.

Our engineering study consisted of a site reconnaissance, a review of existing soils and geologic data, and a field investigation consisting of the excavation of twenty-five (25) test pits. The test pits were excavated on November 6 and 7, 2012 to depths of 6.5 to 15± feet below existing ground surface using a Komatsu PC158ULSC excavator. Ground surface elevations were interpolated from the "Topographic Survey of Lease Parcel 'C',"

developed by Chazen Engineering and Land Surveying Company, latest revision dated June 18, 2004.

The locations of the test pits are shown on the "Test Pit Location Plan," which is attached as *Figure 1*. Individual Test Pit logs, which describe the materials encountered, are presented as *Figures 2 through 26*. A key to soil terminology is included as *Figure 27*.

During our test pit investigation, SESI collected eight (8) discrete soil samples from randomly selected locations within the existing landfill materials. The sample depths were field-determined based on screening with a Photo Ionization Detector (PID), visual, and olfactory observations. The samples were submitted to a NYDEC certified laboratory under chain of custody for analysis of the TCL+30/TAL Suite (Target Compound List +30 Tic's/Target Analyte List) which included Total Volatile Organic Compounds (VOC's), Base Neutral Acid Extractable's (BNA's), Target Analyte (TAL) Metals (23 Metals + Cyanide), Pesticides, and Polychlorinated Biphenyls (PCB's) in accordance with Section 2.1 of the NYDEC DER-10 Technical Requirements for Site Investigation and Remediation. The results of the testing are included in the attached Table 2.

All fieldwork was performed under the direct technical observation of a field engineer from SESI Consulting Engineers, P.C. Our representative located the test pits in the field, maintained continuous logs of the explorations as work proceeded, and performed the soil sampling operations in order to develop the required subsurface information. Test pit locations were chosen in areas that would provide a good overall coverage of the landfill materials accessible by the excavation equipment. It should be noted that some areas could not be accessed due to steep slopes and risky terrain created by the stockpiled concrete material.

Geotechnical soil samples, suitable for identification purposes, were also extracted from the test pits at various intervals. All soil samples extracted in the field were brought to our office where they were examined in our soil mechanics laboratory.

Geotechnical laboratory classification testing consisted of eight (8) mechanical grain size analyses and two (2) percent passing sieve No. 200 tests. The results of the percent passing sieve No. 200 tests are included on the individual test pit logs. The results of the mechanical grain size analyses are presented in graphical form as *Figures 28 through 35*.

SUBSURFACE CONDITIONS

Geology

The United States Geological Survey indicates that the site soils are mapped as younger ground moraine deposited during the Quaternary Period. The soils generally consist of an unassorted mixture of clay, silt, sand, gravel, and boulders ranging from GM to GC to SM. The soils can be locally overlain by small, thin swamps containing muck and peat and stream courses with postglacial alluvium. The soil thickness of the ground moraine is very irregular; however, thicknesses are generally less than 25 feet. Bedrock in this area is classified as a coarse mica schist and mica gneiss.

Site Specific Subsurface Conditions

The natural soils, where encountered, are in general agreement with the geologic mapping. Based on the individual test pit logs, there is a layer of topsoil and vegetation over the majority of the landfill followed by a variable thickness layer of fill consisting of soil mixed with C&D debris, C&D debris mixed with soil, or dredge materials.

The generalized subsurface conditions encountered are:

Surface Materials: A majority of the test pits were excavated through topsoil ranging in thickness from 2 inches to 2 feet. At TP-15 and TP-16, which were located in one of the areas of dredge material spoils, there was a topsoil like material at the surface consisting of primarily brown coarse to fine sand, some silt, and little coarse to fine gravel.

Fill: A miscellaneous fill was encountered in the majority of the test pits to depths of up to ± 15 feet below grade. In most locations, the fill consisted of a mixture of construction and demolition debris containing mostly concrete with brick, metal, rebar, wire, etc. and coarse to fine sand, with varying amounts of silt and gravel. There were areas of fill that consisted of primarily clayey silt with varying amounts of sand, gravel, peat, and other organic material. These areas are likely the results of historical dredging activities at offsite locations. Numerous golf balls were observed in the dredge material indicating that they may have come from a golf course swamp cut or pond dredging event. All of the site fills appeared to have been placed haphazardly with no compactive efforts applied. Concrete and other C&D debris varied drastically depending on location. The location of each of the different material types is discussed further in the "Discussion and Recommendations" section of this report.

Based on interpolation of original and existing topographies, it appears that the landfill thicknesses range from approximately $64\pm$ feet at the thickest point in the southwest side of the landfill to approximately $5\pm$ feet at the thinnest point in the northeast side and along the perimeter of the landfill.

The Gannett Fleming investigation in the western portion of the landfill indicated between 20 and 80 percent of the material encountered was C&D debris that could be processed and reused. SESI's investigation over the majority of the landfill found areas with little to no C&D to as much as 80 percent C&D materials. It should be expected that the composition of the landfill will vary greatly from one location to another and with depth.

Natural Glacial Soils: The natural glacial soils were encountered beneath the fill in two (2) of the test pits (STP-10 and STP-22) to their completion depths ranging from $13.5\pm$ to $15\pm$ feet below grade. The natural soils consisted of primarily reddish brown clay or coarse to fine sand with varying amounts of silt and gravel. Mottling was present in both layers of natural soils encountered; likely caused by oxidation resulting from fluctuating groundwater elevations.

Groundwater: Groundwater was encountered in five (5) of the twenty five (25) test pits at depths ranging from $4.5\pm$ feet to $12\pm$ feet below existing grade. The groundwater

encountered in STP-2, STP-9, and STP-11 is likely perched groundwater created as water percolates into the landfill and encounters confining soil strata. The groundwater levels encountered at STP-10 and STP-22 were more likely the true groundwater levels indicative of the surrounding area as these test pits were advanced through a thinner layer of landfill materials and into the natural site soils. The groundwater at STP-10 and STP-22 corresponds to an elevation of 302± and 310± respectively. The groundwater elevation can be seasonally dependent and vary with the amount of recent precipitation.

Environmental Conditions

During the preliminary environmental investigation of the site, sample depths were field-determined based on screening with a Photo Ionization Detector (PID), visual, and olfactory observations. The readings on the PID were negligible; however, in some test pits, staining and odors were observed. Sampling was biased towards these locations to provide a better indication of the contamination present within the landfill. The results of the environmental testing can be found in Table 2 of this report, which presents the analytical results for the eight (8) soil samples that were collected during the investigation.

DISCUSSION AND RECOMMENDATIONS

Geotechnical Results Summary

A preliminary review of the existing landfill topography and the historical topography prior to the landfill activities indicates that the approximate quantity of landfill material totals 250,000 to 300,000± cubic yards. This quantity is based on rough quantity take off of the apparent landfill extents. The amount of C&D associated with each test pit is presented on Table 1 attached to this report. The average quantity of C&D associated with the test pits during our investigation was approximately 20-40%; however, some areas contained little to no C&D while others contained C&D materials in excess of 80 percent. It should be anticipated that the amount of C&D materials will vary greatly throughout the landfill. Based on the results of our preliminary investigation, there were three distinct types of material present within the portion of the landfill investigated:

Soils with C&D debris

These soils are believed to comprise a majority of the landfill and estimated to be in excess of 150,000 c.y. These materials were primarily present in the western half of the landfill and are believed to extend below the depth of the test pit excavations. The fill generally consisted of coarse to fine sand, with varying amounts of silt and gravel mixed with varying amounts of construction and demolition debris containing mostly concrete with brick, metal, rebar, wire, etc.

C&D debris with Soils

These materials are haphazardly placed around the entire landfill; however, they are largely concentrated in the central to east side of the landfill where they comprise a large debris field that contains large quantities of concrete; in many cases containing little to no soils intermixed. The large central section of the landfill was not accessible during the investigation because the concrete field was not safe to access with the trackhoe. The

quantity of the C&D debris with soils is estimated to be in excess of 80,000 c.y. It is unclear to what depth this material is present up to; therefore, for estimating purposes, the entire area extending to the bottom of the landfill was used in the volume calculation. It should be noted that there are other areas of this type of material throughout the landfill. This material type represents the most readily recoverable materials for potential reuse.

Dredge Materials

The landfill materials stockpiled in the southeastern corner of the site consist primarily of clayey silt with varying amounts of sand, gravel, peat, and other organic material. These materials were reportedly dredge spoils from a project known as Van Cortlandt Park Lake. During the preliminary investigation, similar material types were observed in the large stockpile in the southeast corner of the landfill and in two stockpiles in the southwest corner of the landfill. The quantity of this material in all four locations is estimated to be in excess of 40,000 c.y.

This investigation was only preliminary, therefore, based on the limitations of the equipment used (depth attained), we were not able to geotechnically characterize the entire landfill. An additional investigation will be required in order to determine the fill properties at depths in excess of 15 to 20± feet below grade.

Preliminary Geotechnical Recommendations

The existing subsurface conditions are poor from a building foundation support standpoint. The existing landfill materials would consolidate under the any new fill and building loads, resulting in unacceptable total and differential settlements. In addition, uncontrolled fills have no allowable bearing capacity and would either need to be improved in-place or bypassed if any future buildings are planned on the landfill.

If order to construct any future buildings on the landfill and eliminate any differential settlements, they could be supported on deep foundations (e.g piles). Without removing the larger C&D materials, the pile option may require pre-drilling, making this option very costly. In addition, a structural pile-supported slab would also be required with this option.

In order to construct any future buildings over the landfill using conventional shallow foundations and a slab-on-grade, would be to improve the existing landfill materials in-place using Dynamic compaction. Dynamic compaction is a method of compacting thick deposits of marginal materials in-place without the need for removal and replacement. This treatment will greatly reduce both total and differential settlements, does not require excavation and dewatering, and is significantly less costly than the pile option. This option will also greatly reduce the amount of differential settlement between the building and the site utilities and amenities. Some small long-term post-construction settlements will occur with this option, but they should be well within tolerable limits for the planned type of construction.

If buildings are going to be proposed over the landfill, it should be discussed with the NYSDEC and become part of the landfill closure plan.

Roadway Area Preparation Procedures

We understand that you may be constructing an access road through the landfill which will require some reworking of the landfill materials. In general, the roadway preparation procedures should consist of:

Any asphalt, vegetation or topsoil should be removed from the roadway areas, prior to placing additional fill. Also, the subgrade should be proofrolled with a heavy vibratory roller and compacted to 95 percent of Modified Proctor density (ASTM D-1557) prior to placing additional fill or the pavement section.

Any soft areas disclosed during the proofrolling should be excavated to suitable material and backfilled with a granular fill in 12 inch compacted lifts. Fill placed in the roadway areas should be compacted to 95 percent of Modified Proctor density (ASTM D-1557). Wetting or drying of the fill materials should be accomplished as necessary to achieve the required density.

If offsite borrow material is required, it should have a maximum particle size of 6 inches and the maximum amount of fines (percentage passing a No. 200 mesh sieve) should be 15% to help facilitate construction during wet weather. The "fines" should be non-plastic. It may be possible to reuse some of the existing C&D materials provided that there are sufficiently broken up to create a well-graded material for roadway support.

It should be noted that some of the landfill materials have a relatively high silt/clay content and will be difficult to compact when wet. In addition, the materials may be over-optimum in their present condition. Wetting or drying of the fill material should be accomplished as necessary to achieve the required density.

We should be provided with the Concept Development Plans when they are completed so we can develop geotechnical details for construction.

Environmental Results Summary

The results of the environmental testing were compared to the New York State Unrestricted Use Criteria and the Soil Cleanup Objectives (SCO's) presented in 6 NYCRR Part 375-6, last updated December 2006. Based on comparison of the environmental testing results to the SCO's, all samples yielded exceedances to Unrestricted Use Criteria. In addition, exceedances of the Restricted SCO's were observed for Metals, Pesticides, and Semi-Volatile Organic Compounds (SVOC's). These exceedances will limit the beneficial reuse locations. It should be noted that iron content was the exceedance in the metals category and may be typical of background concentrations of this specific metal.

Gannett Fleming's results were similar, with exceedances of the RSCO's in six of the eight samples they collected for Metals and SVOC's.

Additional sampling and testing will be required if the material is to be processed and/or completely removed from the site. The sampling frequency will need to be determined based on discussions with the NYSDEC.

Recommendations for Landfill Closure

The New York Department of Environmental Conservation (NYDEC) issued a letter on June 16, 2004 outlining four alternate remedial actions that could be taken for the landfill. The following are the four alternatives presented by the NYDEC:

1. Close the landfill according to an approved Engineering Plan.
2. Completely remove the landfill without processing any of the fill materials.
3. Process some of the salvageable construction and demolition waste such as concrete, brick, rock, etc. for reuse and close the landfill with the remaining materials and monitor using necessary institutional and engineering controls. A Beneficial Use Determination would be necessary for the material and institutional and engineering controls would also be necessary for the processed materials in addition to those for the landfill to prevent human exposure and migration of any residual contaminants to the surrounding soils and groundwater.
4. Same as Alternate #3, however the remaining landfill materials would be removed.

Based on the results of the Environmental Testing, we cannot currently render any judgments pertaining to the environmental quality of the entire landfill as it currently exists. Based on our limited preliminary testing, there is contamination present within the landfill materials exceeding both the unrestricted and restricted SCO's and additional testing will likely be required depending on the alternate chosen.

Based on the results of our preliminary investigation and review of the documents provided, we have the following comments on the four alternates presented above:

- Alternate #1 would be the cheapest option in the short-term, but would require capping of the landfill with clean fill and long-term monitoring. It may also restrict any future development of the site and/or require costly foundation support.
- Alternate #2 is the most costly option, but would allow for unrestricted use of the site. This option is not likely to be economically feasible.
- Alternate #3 would reduce the size and extents of the landfill and would provide additional developable space, but the remaining landfill materials would still need to be capped and long term monitoring would still be required. It may be possible to generate money by processing the C&D to help offset the costs of the landfill closure. We recommend that the C&D processing be discussed with a contractor to see if it makes economic sense.
- Alternate #4 would allow for unrestricted use of the site and it may be possible to offset some of the costs by processing the C&D materials to help offset the removal costs. This option would likely be preferred over Alternate #2.

Once the development plans have been prepared for the project, we should discuss these alternates to determine the best approach for closure of the landfill. It would also be helpful to have input from a contractor who would process the C&D materials.

Additional Information Required

In order to fully assess the landfill closure options and provide final recommendations, we should be provided with the following additional documents referenced in the letters described in the history section of this report. This includes:

- The NYSDEC approved Landfill Closure Plan
- Any other NYSDEC approved engineering plans
- Original report dated December 14, 2000 referenced in the NYSDEC letter dated April 20, 2001
- Post Closure Monitoring and Maintenance Manual (if developed)
- Beneficial Use Determination approved by the DEC

If the College does not have this information, SESI can request the information from the NYSDEC through the Freedom of Information Law (FOIL) or from the case manager at the NYSDEC.

Additional Investigations

Additional investigations may be required by the NYSDEC to better characterize the extents, depth and composition of the landfill. This may include:

- Soil borings through the landfill with additional environmental sampling.
- Test pits around the perimeter of the landfill to determine the lateral extents of the landfill.
- Installation of groundwater monitoring wells around the perimeter and beneath the landfill to determine if there are any environmental impacts to the groundwater.

Recommended Next Steps

- Develop concept development plans for our review.
- Review the additional information requested.
- Perform additional investigations of the landfill, if required.
- Develop a conceptual landfill closure plan.
- Develop costs estimates for the landfill closure.
- Meet with the NYDEC case manager to discuss specific requirements for the landfill closure.

LIMITATIONS

The subsurface data reviewed identifies the subsurface conditions only at the locations of the test holes and at the depths where the samples were taken. SESI Consulting Engineers, PC reviews the published geologic data and the field data and uses their professional judgment and experience to render an opinion on the subsurface conditions throughout the site. Because the actual subsurface conditions may differ, we recommend that SESI be retained to provide construction observation services in order to minimize the risks associated with unanticipated conditions.

This report should not be used:

- When the nature of the proposed structure is changed;
- When the size or configuration of the proposed structure is altered;
- When the location or orientation of the proposed structure is modified;
- When there is a change in ownership; or
- For application to an adjacent or any other site.

SESI shall not accept any responsibility for problems which may occur if SESI is not consulted when there are changes to the factors considered in this report's development. The soil logs should not be separated from the Engineering Report in order to minimize the likelihood of soil log misinterpretation.

DISCLAIMER

This Report was prepared by SESI for the sole and exclusive use of Purchase College Advancement Corporation. Nothing under the Professional Services Agreement between SESI and its client, Purchase College Advancement Corporation shall be constructed to give any rights or benefits to anyone other than Client and SESI, and all duties and responsibilities undertaken pursuant to the Agreement will be for the sole and exclusive benefit of Client and SESI and not for the benefit of any other party. This Report has been prepared and issued subject to the express conditions that same is not to be disseminated to anyone other than Client, without the advance written consent of SESI (which SESI, in its sole discretion, is free to grant or withhold). Use of the Report by any other person is unauthorized and such use is at the sole risk of the user.

Attachment 7 Concept Plans

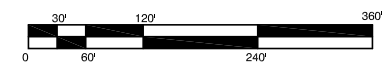

**PURCHASE COLLEGE
SENIOR LEARNING COMMUNITY**

TOWN / VILLAGE OF HARRISON,
WESTCHESTER, NEW YORK

OPEN SPACE / PARK

**SCHEMATIC DESIGN
OVERALL SITE PLAN**

Date: 9 August 2013

Drawing Number: **L-03**



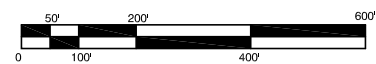
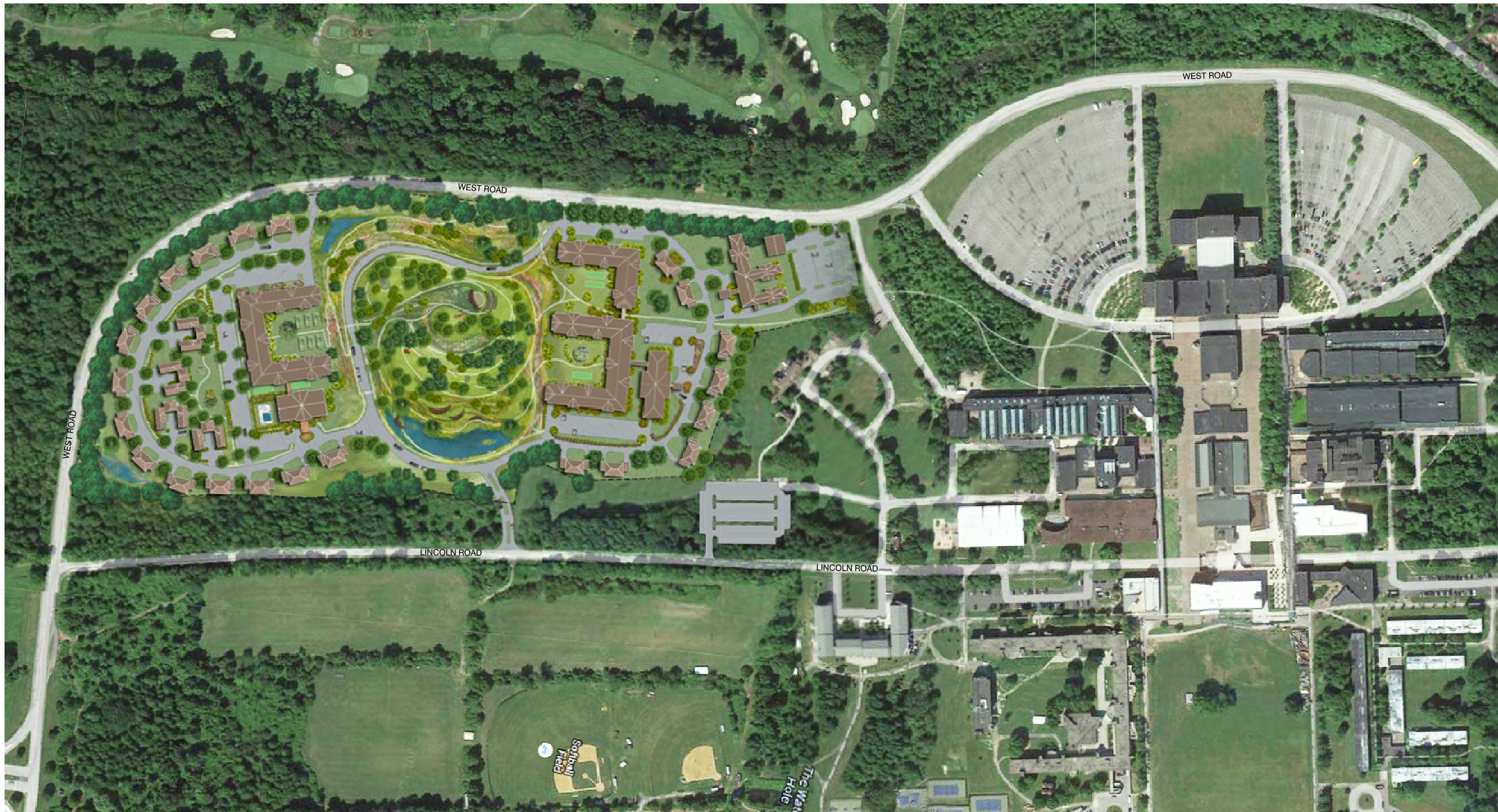

**PURCHASE COLLEGE
SENIOR LEARNING COMMUNITY**

TOWN / VILLAGE OF HARRISON,
WESTCHESTER, NEW YORK

OPEN SPACE / PARK

**SCHEMATIC DESIGN
CONTEXT PLAN**

Date: 9 August 2013

Drawing Number: **L-02**





**PURCHASE COLLEGE
SENIOR LEARNING COMMUNITY**

TOWN / VILLAGE OF HARRISON,
WESTCHESTER, NEW YORK

OPEN SPACE / PARK
**SCHEMATIC DESIGN
ENLARGEMENT PARK PLAN**

Date: 9 August 2013

Drawing Number: **L-04**

